

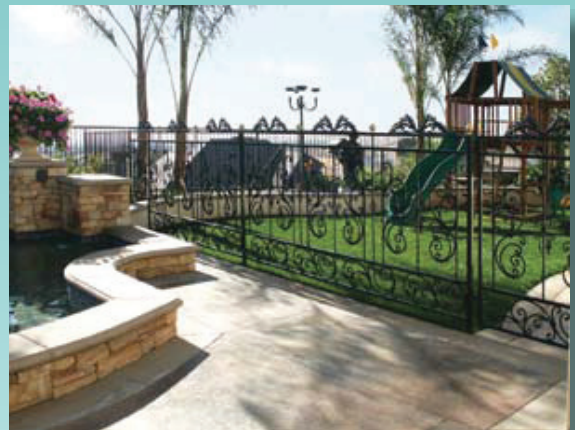

SUPERIOR
BUILDING
PRODUCTS

Steel Fencing/Gates Catalog

(Effective - January 2012)

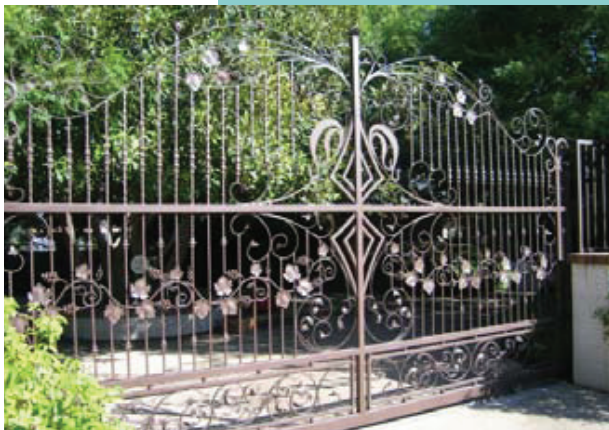

LIT303 (1-12)





TABLE OF CONTENTS

LIST PRICE CATALOG - Effective September 18, 2011

Products	Page
Residential Fencing & Gates	1-6
Economy Fencing, Gates, and Posts	1-2
Standard Residential Fencing & Gates	3-6
Commercial Fencing & Gates	7-22
Posts	23
Hardware	24-26
Hinges	25
Rolling Gate Hardware	26
Lock Boxes	27
Custom Applications	28-33
Arching or Swooping	28
Double Drive Gates	29
Embellishments	30
Special Panels	31
Rolling Gates	32
Trussing	33
Spears	34
Castings	35
Hand Rail Accessories	36
Tabs	37
Perforated Metal Sheets	38
Expanded Metal Sheets	39
Terms and Conditions	40



ECONOMY RESIDENTIAL FENCING & GATES

Product Line: G3840

Monarch Residential Fence

Series 2160

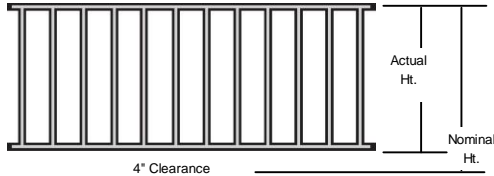

- Frame:** 1" Square Top and Bottom Rail, 18 Ga. Standard or Biasable
- Pickets:** 5/8" Square Pickets, 19 Gauge
3-7/8" Picket Spacing, 4-1/2" Picket Center
- Finish:** Black Powder Coat Only

Price Code: L11

		WIDTH				
		8'-0" (94")		10'-0" (118")		
HEIGHT	Nominal	Actual	Standard	Biasable	Standard	Biasable
	3'0"	32"	\$100.92	\$105.97	\$123.37	\$129.54
	3'6"	38"	\$110.19	\$115.70	\$134.94	\$141.68
	4'0"	44"	\$119.46	\$125.44	\$146.52	\$153.85
	5'2"	58"	\$141.11	\$148.17	\$173.53	\$182.20
	6'0"	68"	\$156.57	\$164.40	\$192.82	\$202.46

Sample Item Number 2160BK8036 = Series 2160, Color Black, Size 8'0" wide x 3'6" high
 Sample Item Number 2160BK8036B = Series 2160, Color Black, Size 8'0" wide x 3'6" high, Biasable

Monarch Residential Gate

Series 4160

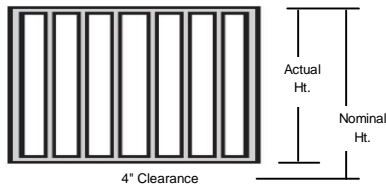

- Frame:** 1" Square Tubing, 18 Gauge
Hardware Sold Separately
- Pickets:** 5/8" Square Tubing, 19 Gauge
3-7/8" Picket Spacing, 4-1/2" Picket Center
- Finish:** Black Powder Coat Only

Price Code: L11

		OPENING WIDTH		
		3'-0" (33")	4'-0" (45")	
HEIGHT	Nominal	Actual		
	3'0"	32"	\$78.01	\$93.17
	3'6"	38"	\$83.16	\$99.86
	4'0"	44"	\$88.29	\$106.55
	5'2"	58"	\$98.57	\$122.14
	6'0"	68"	\$108.84	\$133.31

Sample Item Number 4160BK3036 = Series 4160, Color Black, Size 3'0" wide x 3'6" high

Note: No customized options available with Series 2160 and 4160.

(909) 379-0123 - Fax: (909) 379-0169 - Toll Free (866) 629-6636 - www.superior-bp.com



ECONOMY RESIDENTIAL FENCING & GATES

Product Line: G3840

Serrano Residential Fence

Series 2260

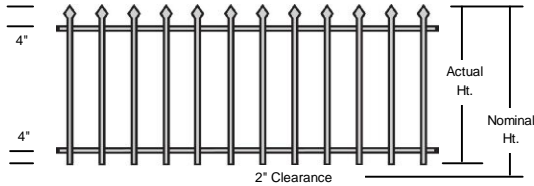

- Frame:** 1" Square Top and Bottom Rail, 18 Ga.
- Pickets:** 5/8" Square Pickets, 19 Gauge
3-7/8" Picket Spacing, 4-1/2" Picket Center
- Finish:** Black Powder Coat Only

Price Code: L11

		WIDTH	
HEIGHT	Nominal	Actual	8'-0" (94")
	5'0"	58"	\$160.37
	6'0"	70"	\$181.23

Sample Item Number 2260BK8060 = Series 2260, Color Black, Size 8'0" wide x 6'0" high

Serrano Residential Gate

Series 4260

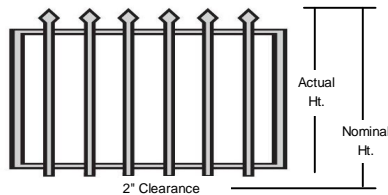

- Frame:** 1" Square Tubing, 18 Gauge
Hardware Sold Separately
- Pickets:** 5/8" Square Tubing, 19 Gauge
3-7/8" Picket Spacing, 4-1/2" Picket Center
- Finish:** Black Powder Coat Only

Price Code: L11

		OPENING WIDTH		
HEIGHT	Nominal	Actual	3'-0" (33")	4'-0" (45")
	5'0"	58"	\$99.41	\$121.48
	6'0"	70"	\$109.68	\$134.87

Sample Item Number 4260BK3050 = Series 4260, Color Black, Size 3'0" wide x 5'0" high

Note: No customized options available with Series 2260, 4260 and PE2014.

Economy Posts

Series PE2014

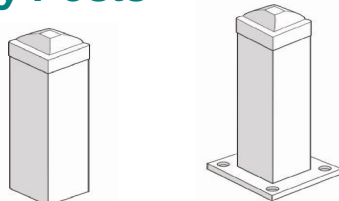

- Post:** 2" Square Post, 14 Gauge
With Pressed Steel Cap
- Finish:** Black Powder Coat Only

Price Code: L11

HEIGHT	Nominal	Actual	Flange	Item #	Each
	3'6"	43"	Yes	PE2014BK36	\$28.00
	7'0"	84"	No	PE2014BK70	\$39.00
	8'0"	96"	No	PE2014BK80	\$47.00

(909) 379-0123 - Fax: (909) 379-0169 - Toll Free (866) 629-6636 - www.superior-bp.com

RESIDENTIAL FENCING & GATES

Product Line: G3843

Royal Residential Fence

Series 2130

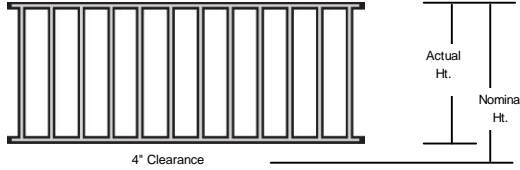

- Frame:** 1" Square Top and Bottom Rail, 16 Gauge
- Pickets:** 5/8" Square Pickets, 18 Gauge
3-7/8" Picket Spacing, 4-1/2" Picket Center
Pickets Welded on Four Sides
- Finish:** Black Powder Coat - Standard
Optional Colors Available

Price Code: L11

		WIDTH				
HEIGHT	Nominal	Actual	8'- 0" (94")	10'- 0" (118")	12'- 0" (142")	Custom Sizes*
	2'0"	20"	\$127.77	\$156.46	\$185.19	Call for quote.
	3'0"	32"	\$163.46	\$201.09	\$238.78	
	3'6"	38"	\$181.30	\$223.40	\$265.58	
	4'0"	44"	\$199.13	\$245.72	\$292.37	
	4'2"	46"	\$205.08	\$253.16	\$301.30	
	4'6"	50"	\$216.97	\$268.03	\$319.15	
	5'0"	56"	\$234.81	\$290.36	\$345.95	
	5'2"	58"	\$240.76	\$297.80	\$354.89	
	6'0"	68"	\$270.50	\$334.99	\$399.54	

Sample Item Number 2130BK8036 = Series 2130, Color Black, Size 8'0" wide x 3'6" high

* For pricing purposes, the minimum width is 6 feet.

Royal Residential Gate

Series 4130

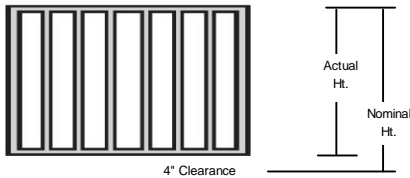

- Gates are Build-to-Order**
- Frame:** 1" Square Tubing, 16 Gauge
Drilled for "J" Bolts
Hardware Sold Separately
- Pickets:** 5/8" Square Tubing, 18 Gauge
- Finish:** Black Powder Coat - Standard
Optional Colors Available

Price Code: L11

		OPENING WIDTH				
HEIGHT	Nominal	Actual	Up to 3'- 0" (33")	Up to 4'- 0" (45")	Up to 5'- 0" (57")	Up to 6'- 0" (69")
	Up to 3'0"	32"	\$86.68	\$103.52	\$120.44	\$137.20
	Up to 3'6"	38"	\$92.40	\$110.96	\$129.59	\$148.08
	Up to 4'0"	44"	\$98.10	\$118.39	\$138.75	\$158.97
	Up to 5'0"	56"	\$109.52	\$133.26	\$157.06	\$180.72
	Up to 5'2"	58"	\$111.41	\$135.71	\$160.09	\$184.34
	Up to 6'0"	68"	\$120.93	\$148.12	\$175.38	\$202.49

Sample Item Number 4130BK4036 = Series 4130, Color Black, Size 4'0" wide x 3'6" high

Royal Residential Options (Product Line: Z9999)

- Biasable Fencing (Excludes Fixed Bias) OP-BIASABLE Add \$1.25 per lineal foot.
- 1-1/2" x 1-1/2" Top and Bottom Rails OP-RAIL-1TO1.5 Add \$3.00 per lineal foot.

(909) 379-0123 - Fax: (909) 379-0169 - Toll Free (866) 629-6636 - www.superior-bp.com

Apache Residential Fence

Series 2230

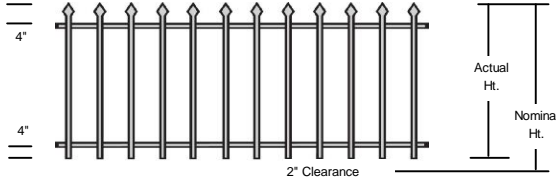

Frame: 1" Square Top and Bottom Rail, 16 Gauge
Pickets: 5/8" Square Pickets, 18 Gauge
 3-7/8" Picket Spacing, 4-1/2" Picket Center
 Punched Spear Point on Pickets
Finish: Black Powder Coat - Standard
 Optional Colors Available

Price Code: L11

		WIDTH				
HEIGHT	Nominal	Actual	8'-0" (94")	10'-0" (118")	12'-0" (142")	Custom Sizes*
	2'0"	22"	\$108.61	\$132.37	\$156.13	Call for quote.
	3'0"	34"	\$131.81	\$161.30	\$190.81	
	3'6"	40"	\$143.40	\$175.78	\$208.16	
	4'0"	46"	\$154.99	\$190.25	\$225.50	
	5'0"	58"	\$178.19	\$219.19	\$260.19	
	6'0"	70"	\$201.37	\$248.12	\$294.86	

Sample Item Number 2230BK8036 = Series 2230, Color Black, Size 8'0" wide x 3'6" high

* For pricing purposes, the minimum width is 6 feet.

Apache Residential Gate

Series 4230

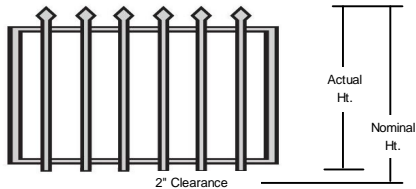

Gates are Build-to-Order
Frame: 1" Square Tubing, 16 Gauge
 Hardware Sold Separately
Pickets: 5/8" Square Tubing, 18 Gauge
Finish: Black Powder Coat - Standard
 Optional Colors Available

Price Code: L11

		OPENING WIDTH				
HEIGHT	Nominal	Actual	Up to 3'-0" (33")	Up to 4'-0" (45")	Up to 5'-0" (57")	Up to 6'-0" (69")
	Up to 3'0"	34"	\$87.62	\$105.25	\$123.03	\$140.66
	Up to 3'6"	40"	\$93.34	\$112.68	\$132.17	\$151.54
	Up to 4'0"	46"	\$99.04	\$120.12	\$141.34	\$162.41
	Up to 5'0"	58"	\$110.46	\$134.98	\$159.64	\$184.18
	Up to 6'0"	70"	\$121.87	\$149.85	\$177.97	\$205.95

Sample Item Number 4230BK4036 = Series 4230, Color Black, Size 4'0" wide x 3'6" high

Apache Residential Options (Product Line: Z9999)

- 1-1/2" x 1-1/2" Top and Bottom Rails OP-RAIL-1TO1.5 Add \$3.00 per lineal foot.

RESIDENTIAL FENCING & GATES

Product Line: G3843

Regency Residential Fence

Series 2330

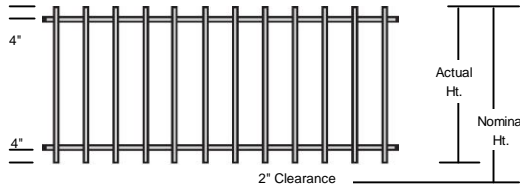

Frame: 1" Square Top and Bottom Rail, 16 Gauge
Pickets: 5/8" Square Pickets, 18 Gauge
 3-7/8" Picket Spacing, 4-1/2" Picket Center
Finish: Black Powder Coat - Standard
 Optional Colors Available

Price Code: L11

		WIDTH				
HEIGHT	Nominal	Actual	8'-0" (94")	10'-0" (118")	12'-0" (142")	Custom Sizes
	2'0"	22"	\$114.57	\$139.85	\$165.19	Call for quote.
	3'0"	34"	\$139.81	\$171.37	\$203.01	
	3'6"	40"	\$152.42	\$187.14	\$221.91	
	4'0"	46"	\$165.04	\$202.90	\$240.82	
	4'6"	52"	\$177.67	\$218.66	\$328.09	
	5'0"	58"	\$190.28	\$234.43	\$354.89	
	6'0"	70"	\$215.51	\$342.43	\$408.47	

Sample Item Number 2330BK8036 = Series 2330, Color Black, Size 8'0" wide x 3'6" high

* For pricing purposes, the minimum width is 6 feet.

Regency Residential Gate

Series 4330

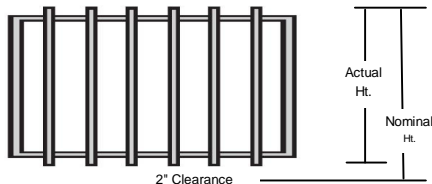

Gates are Build-to-Order
Frame: 1" Square Tubing, 16 Gauge
 Drilled for "J" Bolts
 Hardware Sold Separately
Pickets: 5/8" Square Tubing, 18 Gauge
Finish: Black Powder Coat - Standard
 Optional Colors Available

Price Code: L11

		OPENING WIDTH				
HEIGHT	Nominal	Actual	Up to 3'-0" (33")	Up to 4'-0" (45")	Up to 5'-0" (57")	Up to 6'-0" (69")
	Up to 3'0"	34"	\$77.08	\$92.87	\$108.71	\$124.44
	Up to 3'6"	40"	\$82.50	\$99.85	\$117.26	\$134.57
	Up to 4'0"	46"	\$87.91	\$106.84	\$125.82	\$144.69
	Up to 5'0"	58"	\$98.74	\$120.81	\$142.93	\$164.95
	Up to 6'0"	70"	\$109.56	\$134.77	\$160.05	\$185.21

Sample Item Number 4330BK4036 = Series 4330, Color Black, Size 4'0" wide x 3'6" high

Regency Residential Options (Product Line: Z9999)

• 1-1/2" x 1-1/2" Top and Bottom Rails OP-RAIL-1TO1.5 Add \$3.00 per lineal foot.

(909) 379-0123 - Fax: (909) 379-0169 - Toll Free (866) 629-6636 - www.superior-bp.com

RESIDENTIAL FENCING & GATES

Product Line: G3843

Corsican Residential Fence

Series 2630 - Arched
Series 2632 - Straight

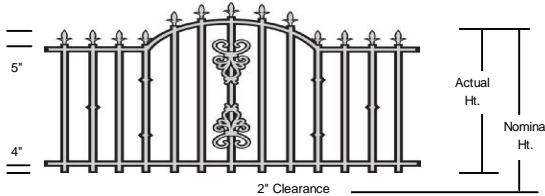

Frame: 1" Square Top and Bottom Rail, 16 Gauge
Pickets: 5/8" Square Pickets, 18 Gauge
 3-7/8" Picket Spacing, 4-1/2" Picket Center
 Corsican Casting; Classic Cast Spear
Finish: Black Powder Coat - Standard
 Optional Colors Available

Price Code: L11

		WIDTH								
HEIGHT	Nominal	Actual	8'-0" (94")		10'-0" (118")		12'-0" (142")		Custom Sizes	
			Arched	Straight	Arched	Straight	Arched	Straight	Arched	Straight
	2'0"	22"		166.83	151.52	199.51	181.25	233.7	211.82	Call for quote.
3'0"	34"		192.06	176.76	231.03	212.77	271.52	249.63		
3'6"	40"		204.67	189.38	246.79	228.52	290.42	268.53		
4'0"	46"		217.3	201.99	262.55	244.29	309.33	287.44		
5'0"	58"		242.53	227.23	294.08	275.81	423.39	401.5		
6'0"	70"		267.78	252.47	402.08	383.82	476.98	455.09		

Sample Item Number 2630BK8036 = Series 2630, Color Black, Size 8'0" wide x 3'6" high

* For pricing purposes, the minimum width is 6 feet.

Corsican Residential Gate

Series 4630 - Arched
Series 4632 - Straight

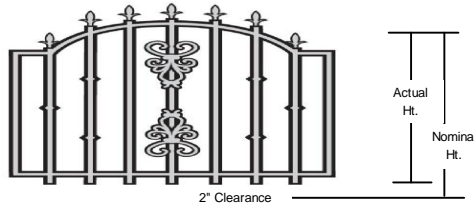

Gates are Build-to-Order
Frame: 1" Square Tubing, 16 Gauge
 Hardware Sold Separately
Pickets: 5/8" Square Tubing, 18 Gauge
 Corsican Casting; Classic Cast Spear
Finish: Black Powder Coat - Standard
 Optional Colors Available

Price Code: L11

		OPENING WIDTH								
HEIGHT	Nominal	Actual	Up to 3'0" (33")		Up to 4'0" (45")		Up to 5'0" (57")		Up to 6'0" (69")	
			Arched	Straight	Arched	Straight	Arched	Straight	Arched	Straight
	Up to 3'0"	34"		\$113.01	\$102.70	\$131.88	\$121.07	\$150.98	\$139.51	\$169.39
Up to 3'6"	40"		\$118.42	\$108.12	\$138.86	\$128.06	\$159.54	\$148.06	\$179.51	\$167.20
Up to 4'0"	46"		\$123.84	\$113.53	\$145.85	\$135.04	\$168.09	\$156.62	\$189.65	\$177.34
Up to 5'0"	58"		\$134.66	\$124.36	\$159.81	\$149.01	\$185.21	\$173.73	\$209.89	\$197.59
Up to 6'0"	70"		\$145.49	\$135.18	\$173.78	\$162.98	\$202.31	\$190.85	\$230.15	\$217.85

Sample Item Number 4630BK4036 = Series 4630, Color Black, Size 4'0" wide x 3'6" high

Corsican Residential Options (Product Line: Z9999)

- 1-1/2" x 1-1/2" Top and Bottom Rails OP-RAIL-1TO1.5 Add \$3.00 per lineal foot.

Royal Commercial Fence, 4-5/8" Picket Centers

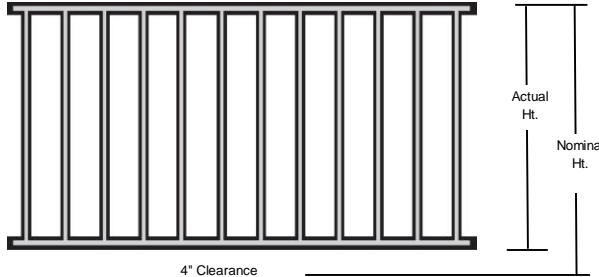

Frame: 1-1/2" Square Top and Bottom Rail, 14 Ga.
Pickets: 3/4" or 1" Pickets, 16 Gauge
 4-5/8" Picket Centers
 Pickets Welded on Four Sides
Finish: Black Powder Coat - Standard
 Optional Colors Available

Series 2140 - 3/4" Pickets

Price Code: L11

		WIDTH				
HEIGHT	Nominal	Actual	8'-0" (94")	10'-0" (118")	12'-0" (142")	Custom Sizes
	3'0"	32"	\$177.59	\$217.83	\$258.14	Call for quote.
	3'6"	38"	\$193.20	\$237.30	\$281.47	
	4'0"	44"	\$208.80	\$256.77	\$304.79	
	5'0"	56"	\$240.04	\$295.70	\$351.45	
	5'2"	58"	\$245.23	\$302.19	\$359.22	
	6'0"	68"	\$271.26	\$334.65	\$398.11	
	7'0"	80"	\$302.48	\$373.60	\$444.78	
	8'0"	92"	\$333.70	\$412.54	\$491.44	
	10'0"	116"	\$396.16	\$490.42	\$584.75	

Sample Item Number 2140BK8036 = Series 2140, Color Black, Size 8'0" wide x 3'6" high

Series 2150 - 1" Pickets

Price Code: L11

		WIDTH				
HEIGHT	Nominal	Actual	8'-0" (94")	10'-0" (118")	12'-0" (142")	Custom Sizes
	3'0"	32"	\$196.38	\$241.88	\$287.44	Call for quote.
	3'6"	38"	\$217.17	\$267.81	\$318.51	
	4'0"	44"	\$237.97	\$293.75	\$349.56	
	5'0"	56"	\$279.58	\$345.58	\$485.30	
	5'2"	58"	\$286.50	\$354.23	\$498.28	
	6'0"	68"	\$321.17	\$471.75	\$563.20	
	7'0"	80"	\$432.39	\$536.73	\$641.12	
	8'0"	92"	\$484.42	\$601.70	\$719.01	
	10'0"	116"	\$588.52	\$731.63	\$874.80	

Sample Item Number 2150BK8036 = Series 2150, Color Black, Size 8'0" wide x 3'6" high

Royal Commercial Fence Options (Product Line: Z9999)

- 1-1/2" x 2" Top and Bottom Rails OP-RAIL-TO1.5X2 Add \$2.25 per lineal foot.
- 2" x 2" Top and Bottom Rails OP-RAIL-1.5TO2 Add \$2.50 per lineal foot.

COMMERCIAL GATES

Product Line G3844

Royal Commercial Gate, 4-5/8" Picket Centers

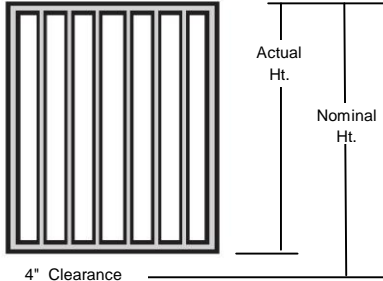

- Frame:** 1-1/2" Square Frame, 14 Ga. - 3' to 9' Width
2" Square Frame, 14 Ga. - 10' to 24' Width
Hardware not included
- Pickets:** 3/4" or 1" Vertical Pickets, 16 Gauge
Pickets Welded on Four Sides
4-5/8" Picket Centers
- Finish:** Black Powder Coat - Standard
Optional Colors Available

Series 4140 - 3/4" Pickets

Price Code: L11

		OPENING WIDTH															
		1-1/2" Perimeter Frame							2" Perimeter Frame								
HEIGHT	Nominal	Actual	3'	4'	5'	6'	7'	8'	9'	10'	12'	14'	16'	18'	20'	22'	24'
	3'0"	32"		126.85	152.09	177.15	202.39	227.63	252.69	277.93	330.40	385.19	439.87	494.75	549.45	604.15	658.85
4'0"	44"		145.22	175.27	205.16	235.23	265.28	295.17	325.24	384.74	449.17	513.50	578.04	642.38	706.71	771.07	835.59
5'0"	56"		163.60	198.47	233.17	268.07	302.95	337.67	372.54	439.05	513.14	587.14	661.31	735.31	809.28	883.28	957.45
5'2"	58"		166.61	202.30	237.81	273.50	309.19	344.70	380.39	448.07	523.75	599.35	675.13	750.73	826.33	901.93	977.71
6'0"	68"		181.95	221.65	261.21	300.91	340.62	380.15	419.85	493.39	577.14	660.77	744.58	828.22	911.88	995.51	1079.32
7'0"	80"		200.32	244.86	289.22	333.75	378.29	422.62	467.16	547.73	641.11	734.41	827.86	921.15	1014.44	1107.71	1201.19
8'0"	92"		218.69	268.04	317.23	366.59	415.94	465.12	514.46	602.07	705.09	808.02	911.15	1014.08	1117.01	1219.94	1323.05

Sample Item Number 4140BK3040 = Series 4140, Color Black, Size 3'0" wide x 4'0" high

Series 4150 - 1" Pickets

Price Code: L11

		OPENING WIDTH															
		1-1/2" Perimeter Frame							2" Perimeter Frame								
HEIGHT	Nominal	Actual	3'	4'	5'	6'	7'	8'	9'	10'	12'	14'	16'	18'	20'	22'	24'
	4'0"	44"		119.66	147.58	175.41	203.36	231.28	259.11	287.06	347.14	407.75	535.52	606.00	676.32	746.65	817.00
5'0"	56"		137.49	170.55	203.49	236.57	269.64	302.60	335.66	403.25	547.25	630.52	713.91	797.18	880.43	963.70	1047.09
5'2"	58"		140.42	174.34	208.15	242.08	276.00	309.81	343.74	412.57	560.89	646.30	731.84	817.26	902.68	988.10	1073.64
6'0"	68"		155.28	193.48	231.59	269.79	307.99	346.07	450.38	533.06	629.33	725.52	821.83	918.02	1014.23	1110.42	1206.72
7'0"	80"		173.11	216.44	259.66	303.00	346.34	458.42	510.64	602.20	711.39	820.52	929.74	1038.88	1148.01	1257.11	1366.36
8'0"	92"		190.93	239.38	287.74	336.21	453.66	512.24	570.91	671.34	793.44	915.49	1037.69	1159.74	1281.79	1403.83	1526.00
10'0"	116"		226.55	285.28	343.88	476.72	548.37	619.86	691.48	809.61	957.58	1105.49	1253.52	1401.43	1549.34	1697.25	1845.27

Sample Item Number 4150BK8060 = Series 4150, Color Black, Size 8'0" wide x 6'0" high

Royal Commercial Gate Options

- Trussing: It is recommended that trussing be used on gates over 12' wide or 6' high. See page 33.

Royal Commercial Fence, 6" Picket Centers

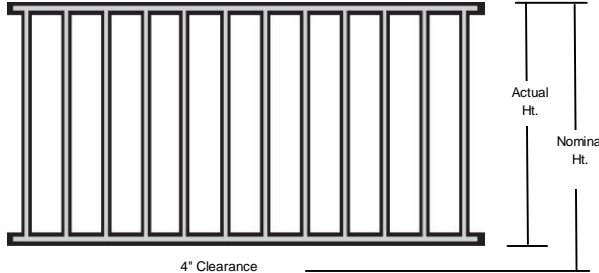

Frame: 1-1/2" Square Top and Bottom Rail, 14 Ga.
Pickets: 3/4" or 1" Pickets, 16 Gauge
 6" Picket Centers
 Pickets Welded on Four Sides
Finish: Black Powder Coat - Standard
 Optional Colors Available

Series 2146 - 3/4" Pickets

Price Code: L11

		WIDTH				
HEIGHT	Nominal	Actual	8'-0" (94")	10'-0" (118")	12'-0" (142")	Custom Sizes
	3'0"	32"	\$157.78	\$193.60	\$229.46	Call for quote.
	3'6"	38"	\$172.67	\$212.13	\$251.68	
	4'0"	44"	\$187.56	\$230.69	\$273.88	
	5'0"	56"	\$217.33	\$267.78	\$391.94	
	5'2"	58"	\$222.30	\$273.96	\$401.96	
	6'0"	68"	\$247.10	\$379.19	\$452.14	
	7'0"	80"	\$346.51	\$429.40	\$512.34	
	8'0"	92"	\$386.73	\$479.60	\$572.55	
	10'0"	116"	\$467.17	\$580.03	\$692.94	

Sample Item Number 2146BK8036 = Series 2146, Color Black, Size 8'0" wide x 3'6" high

Series 2156 - 1" Pickets

Price Code: L11

		WIDTH				
HEIGHT	Nominal	Actual	8'-0" (94")	10'-0" (118")	12'-0" (142")	Custom Sizes
	3'0"	32"	\$171.92	\$211.13	\$250.39	Call For quote.
	3'6"	38"	\$189.46	\$232.95	\$276.53	
	4'0"	44"	\$207.01	\$254.80	\$302.65	
	5'0"	56"	\$242.08	\$298.46	\$428.57	
	5'2"	58"	\$247.93	\$305.74	\$439.89	
	6'0"	68"	\$277.14	\$416.45	\$496.61	
	7'0"	80"	\$381.87	\$473.23	\$564.65	
	8'0"	92"	\$427.38	\$530.01	\$632.72	
	10'0"	116"	\$518.43	\$643.59	\$768.80	

Sample Item Number 2156BK8036 = Series 2156, Color Black, Size 8'0" wide x 3'6" high

Royal Commercial Fence Options (Product Line: Z9999)

- 1-1/2" x 2" Top and Bottom Rails OP-RAIL-TO1.5X2 Add \$2.25 per lineal foot.
- 2" x 2" Top and Bottom Rails OP-RAIL-1.5TO2 Add \$2.50 per lineal foot.

COMMERCIAL GATES

Product Line G3844

Royal Commercial Gate, 6" Picket Centers

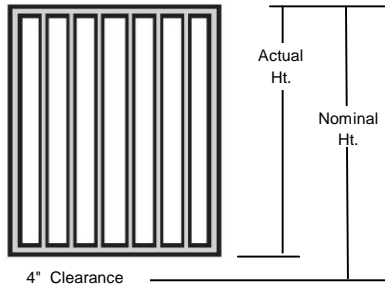

- Frame:** 1-1/2" Square Frame, 14 Ga. - 3' to 9' Width
2" Square Frame, 14 Ga. - 10' to 24' Width
Hardware not included
- Pickets:** 3/4" or 1" Vertical Pickets, 16 Gauge
Pickets Welded on Four Sides
6" Picket Centers
- Finish:** Black Powder Coat - Standard
Optional Colors Available

Series 4146 - 3/4" Pickets

Price Code: L11

		OPENING WIDTH															
		1-1/2" Perimeter Frame								2" Perimeter Frame							
	Nominal	Actual	3'	4'	5'	6'	7'	8'	9'	10'	12'	14'	16'	18'	20'	22'	24'
HEIGHT	3'0"	32"	89.40	107.34	125.26	143.26	161.20	179.12	197.06	244.79	285.45	326.10	366.84	407.50	518.38	566.17	614.00
	4'0"	44"	103.49	125.10	146.68	168.34	189.95	211.53	233.13	286.93	334.91	450.11	507.96	565.71	623.48	681.26	739.08
	5'0"	56"	117.59	142.86	168.10	193.43	218.70	243.94	269.21	329.06	457.48	525.23	593.07	660.82	728.57	796.35	864.16
	5'2"	58"	119.92	145.78	171.64	197.59	223.45	249.31	275.20	336.03	468.30	537.71	607.20	676.63	746.04	815.48	884.97
	6'0"	68"	131.69	160.62	189.53	218.51	247.44	276.35	371.39	444.86	522.61	600.35	678.18	755.92	833.67	911.44	989.24
	7'0"	80"	145.79	178.38	210.95	243.60	276.19	377.65	419.13	500.00	587.74	675.48	763.29	851.03	938.77	1026.53	1114.32
	8'0"	92"	159.88	196.14	232.37	268.69	373.94	420.40	466.87	555.14	652.86	750.60	848.41	946.13	1043.87	1141.62	1239.41

Sample Item Number 4146BK3040 = Series 4146, Color Black, Size 3'0" wide x 4'0" high

Series 4156 - 1" Pickets

Price Code: L11

		OPENING WIDTH															
		1-1/2" Perimeter Frame								2" Perimeter Frame							
	Nominal	Actual	3'	4'	5'	6'	7'	8'	9'	10'	12'	14'	16'	18'	20'	22'	24'
HEIGHT	4'0"	44"	108.74	132.68	156.59	180.59	204.53	228.44	252.38	308.51	361.15	481.03	543.54	605.96	668.39	730.84	793.32
	5'0"	56"	124.27	152.51	180.72	209.02	237.26	265.47	293.70	356.53	490.89	564.58	638.35	712.04	785.73	859.45	933.20
	5'2"	58"	126.84	155.78	184.71	213.74	242.67	271.61	300.57	364.48	502.90	578.45	654.10	729.69	805.24	880.83	956.48
	6'0"	68"	139.80	172.34	204.85	237.44	269.98	302.49	401.14	478.22	563.17	648.13	733.17	818.12	903.08	988.06	1073.07
	7'0"	80"	155.33	192.17	228.98	265.87	302.71	408.40	454.13	539.24	635.46	731.68	827.98	924.20	1020.42	1116.67	1212.95
	8'0"	92"	170.86	211.99	253.10	294.30	404.43	455.76	507.12	600.26	707.74	815.23	922.80	1030.28	1137.77	1245.28	1352.82
	10'0"	116"	201.92	251.65	301.36	425.26	487.88	550.48	613.10	722.30	852.32	982.33	1112.43	1242.45	1372.46	1502.50	1632.57

Sample Item Number 4156BK8060 = Series 4156, Color Black, Size 8'0" wide x 6'0" high

Royal Commercial Gate Options

- Trussing: It is recommended that trussing be used on gates over 12' wide or 6' high. See page 33.

Apache Commercial Fence, 4-5/8" Picket Centers

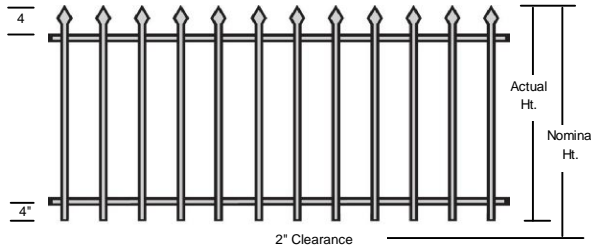

Frame: 1-1/2" Square Top and Bottom Rail, 14 Ga.
Pickets: 3/4" or 1" Pickets, 16 Gauge
 4-5/8" Picket Centers
 Pickets Welded on Four Sides
Finish: Black Powder Coat - Standard
 Optional Colors Available

Series 2240 - 3/4" Pickets

Price Code: L11

		WIDTH				
HEIGHT	Nominal	Actual	8'-0" (94")	10'-0" (118")	12'-0" (142")	Custom Sizes
	3'0"	32"	\$184.95	\$226.98	\$269.08	Call for quote.
	3'6"	38"	\$200.56	\$246.45	\$292.42	
	4'0"	44"	\$216.17	\$265.93	\$315.73	
	5'0"	56"	\$247.39	\$304.86	\$362.39	
	6'0"	68"	\$278.63	\$343.80	\$409.07	
	7'0"	80"	\$309.85	\$382.75	\$455.72	
	8'0"	92"	\$341.07	\$421.68	\$502.38	
	10'0"	116"	\$403.51	\$499.57	\$595.69	

Sample Item Number 2240BK8036 = Series 2240, Color Black, Size 8'0" wide x 3'6" high

Series 2250 - 1" Pickets

Price Code: L11

		WIDTH				
HEIGHT	Nominal	Actual	8'-0" (94")	10'-0" (118")	12'-0" (142")	Custom Sizes
	3'0"	32"	\$205.12	\$252.74	\$300.43	Call for quote.
	3'6"	38"	\$225.91	\$278.68	\$331.50	
	4'0"	44"	\$246.71	\$304.61	\$362.54	
	5'0"	56"	\$288.30	\$356.45	\$500.92	
	6'0"	68"	\$329.91	\$484.80	\$578.84	
	7'0"	80"	\$442.87	\$549.77	\$656.74	
	8'0"	92"	\$494.90	\$614.72	\$734.63	
	10'0"	116"	\$598.97	\$744.68	\$890.42	

Sample Item Number 2250BK8036 = Series 2250, Color Black, Size 8'0" wide x 3'6" high

Apache Commercial Fence Options (Product Line: Z9999)

- 1-1/2" x 2" Top and Bottom Rails OP-RAIL-TO1.5X2 Add \$2.25 per lineal foot.
- 2" x 2" Top and Bottom Rails OP-RAIL-1.5TO2 Add \$2.50 per lineal foot.

COMMERCIAL GATES

Product Line G3844

Apache Commercial Gate, 4-5/8" Picket Centers

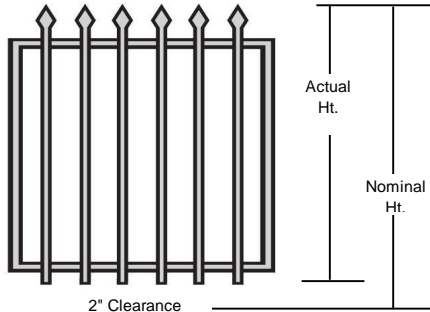

- Frame:** 1-1/2" Square Frame, 14 Ga. - 3' to 9' Width
2" Square Frame, 14 Ga. - 10' to 24' Width
Hardware not included
- Pickets:** 3/4" or 1" Vertical Pickets, 16 Gauge
4-5/8" Picket Centers
- Finish:** Black Powder Coat - Standard
Optional Colors Available

Series 4240 - 3/4" Pickets

Price Code: L11

		OPENING WIDTH															
		1-1/2" Perimeter Frame								2" Perimeter Frame							
HEIGHT	Nominal	Actual	3'	4'	5'	6'	7'	8'	9'	10'	12'	14'	16'	18'	20'	22'	24'
	3'0"	34"	126.67	153.08	179.29	205.61	232.00	258.14	284.56	337.08	394.10	451.03	508.17	565.10	622.12	679.05	736.17
3'6"	40"	135.87	164.67	193.29	222.03	250.84	279.39	308.20	364.26	426.09	487.85	549.79	611.55	673.41	735.17	797.11	
4'0"	46"	145.04	176.26	207.30	238.45	269.67	300.62	331.87	391.42	458.10	524.67	591.44	658.01	724.69	791.28	858.03	
5'0"	58"	163.42	199.47	235.33	271.30	307.34	343.12	379.17	445.76	522.07	598.30	674.71	750.94	827.26	903.49	979.90	
6'0"	70"	181.77	222.65	263.34	304.14	344.99	385.60	426.48	500.09	586.05	671.94	757.98	843.87	929.83	1015.72	1101.76	
7'0"	82"	200.14	245.85	291.35	336.98	382.66	428.10	473.79	554.43	650.05	745.57	841.25	936.78	1032.39	1127.92	1223.63	
8'0"	94"	218.51	269.03	319.36	369.82	420.33	470.58	521.09	608.74	714.02	819.18	924.55	1029.71	1134.99	1240.15	1345.49	

Sample Item Number 4240BK3040 = Series 4240, Color Black, Size 3'0" wide x 4'0" high

Series 4250 - 1" Pickets

Price Code: L11

		OPENING WIDTH															
		1-1/2" Perimeter Frame								2" Perimeter Frame							
HEIGHT	Nominal	Actual	3'	4'	5'	6'	7'	8'	9'	10'	12'	14'	16'	18'	20'	22'	24'
	4'0"	46"	119.88	148.91	177.82	206.81	235.84	264.69	293.74	353.70	416.46	484.41	549.41	622.46	695.35	768.33	841.26
5'0"	58"	137.71	171.87	205.92	240.03	274.19	308.18	342.35	409.84	484.57	564.41	644.41	730.37	816.21	902.11	987.95	1073.91
6'0"	70"	155.50	194.81	233.99	273.24	312.52	351.64	390.00	461.81	546.63	636.41	731.41	831.29	931.07	1030.88	1130.67	1230.55
7'0"	82"	173.33	217.77	262.07	306.45	350.87	395.74	440.27	519.27	610.95	712.71	814.41	916.20	1017.90	1119.66	1221.36	1323.18
8'0"	94"	191.15	240.71	290.14	339.67	389.72	439.54	489.54	579.54	680.06	791.77	903.41	1015.15	1126.76	1238.47	1350.08	1461.69
10'0"	118"	226.77	286.60	346.32	406.45	466.39	526.16	586.07	700.07	818.34	946.91	1080.38	1218.98	1357.48	1495.92	1634.31	1772.72

Sample Item Number 4250BK8060 = Series 4250, Color Black, Size 8'0" wide x 6'0" high

Apache Commercial Gate Options

- Trussing: It is recommended that trussing be used on gates over 12' wide or 6' high. See page 33.

COMMERCIAL FENCING

Product Line G3844

Apache Commercial Fence, 6" Picket Centers

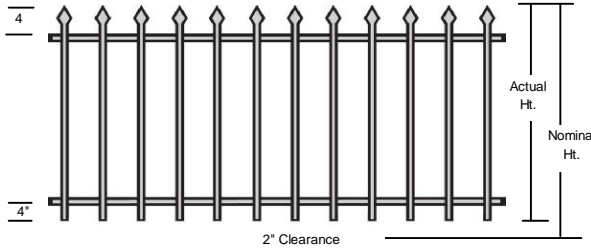

Frame: 1-1/2" Square Top and Bottom Rail, 14 Ga.
Pickets: 3/4" or 1" Pickets, 16 Gauge
 6" Picket Centers
 Pickets Welded on Four Sides
Finish: Black Powder Coat - Standard
 Optional Colors Available

Series 2246 - 3/4" Pickets

Price Code: L11

		WIDTH				
HEIGHT	Nominal	Actual	8'-0" (94")	10'-0" (118")	12'-0" (142")	Custom Sizes
	3'0"	32"	\$164.12	\$201.52	\$238.89	Call for quote.
	3'6"	38"	\$179.02	\$220.05	\$261.11	
	4'0"	44"	\$193.89	\$238.61	\$283.33	
	5'0"	56"	\$223.68	\$275.70	\$404.00	
	6'0"	68"	\$253.44	\$389.30	\$464.20	
	7'0"	80"	\$354.58	\$439.50	\$524.42	
	8'0"	92"	\$394.81	\$489.70	\$584.61	
	10'0"	116"	\$475.23	\$590.13	\$705.03	

Sample Item Number 2246BK8036 = Series 2246, Color Black, Size 8'0" wide x 3'6" high

Series 2256 - 1" Pickets

Price Code: L11

		WIDTH				
HEIGHT	Nominal	Actual	8'-0" (94")	10'-0" (118")	12'-0" (142")	Custom Sizes
	3'0"	32"	\$179.14	\$220.15	\$261.12	Call for quote.
	3'6"	38"	\$196.69	\$241.97	\$287.27	
	4'0"	44"	\$214.21	\$263.81	\$313.41	
	5'0"	56"	\$249.31	\$307.48	\$441.93	
	6'0"	68"	\$284.37	\$427.65	\$509.98	
	7'0"	80"	\$390.81	\$484.43	\$578.04	
	8'0"	92"	\$436.35	\$541.20	\$646.08	
	10'0"	116"	\$527.37	\$654.78	\$782.20	

Sample Item Number 2256BK8036 = Series 2256, Color Black, Size 8'0" wide x 3'6" high

Apache Commercial Fence Options (Product Line: Z9999)

- 1-1/2" x 2" Top and Bottom Rails OP-RAIL-TO1.5X2 Add \$2.25 per lineal foot.
- 2" x 2" Top and Bottom Rails OP-RAIL-1.5TO2 Add \$2.50 per lineal foot.

COMMERCIAL GATES

Product Line G3844

Apache Commercial Gate, 6" Picket Centers

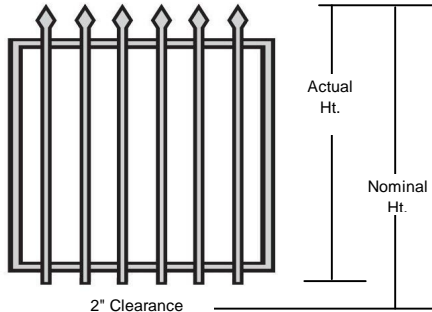

- Frame:** 1-1/2" Square Frame, 14 Ga. - 3' to 9' Width
2" Square Frame, 14 Ga. - 10' to 24' Width
Hardware not included
- Pickets:** 3/4" or 1" Vertical Pickets, 16 Gauge
6" Picket Centers
- Finish:** Black Powder Coat - Standard
Optional Colors Available

Series 4246 - 3/4" Pickets

Price Code: L11

		OPENING WIDTH															
		1-1/2" Perimeter Frame								2" Perimeter Frame							
HEIGHT	Nominal	Actual	3'	4'	5'	6'	7'	8'	9'	10'	12'	14'	16'	18'	20'	22'	24'
	3'0"	34"	88.89	107.61	126.33	145.07	163.78	182.50	201.24	248.49	290.74	332.97	375.22	417.47	459.64	501.90	544.15
3'6"	40"	95.93	116.48	137.05	157.60	178.15	198.71	219.26	269.54	315.46	361.37	407.27	453.18	499.04	544.93	590.85	
4'0"	46"	102.99	125.37	147.75	170.15	192.53	214.91	237.31	290.62	340.20	389.76	439.33	488.91	538.41	587.99	637.56	
5'0"	58"	117.09	143.13	169.17	195.24	221.28	247.32	273.39	332.76	389.66	446.54	503.45	560.35	617.17	674.08	730.98	
6'0"	70"	131.19	160.89	190.60	220.32	250.03	279.73	309.46	374.89	439.12	503.33	567.56	631.79	695.94	760.17	824.40	
7'0"	82"	145.28	178.65	212.02	245.41	278.78	312.14	345.53	417.03	488.58	560.12	631.67	703.23	774.70	846.26	917.81	
8'0"	94"	159.38	196.41	233.44	270.49	307.52	344.56	381.61	459.16	538.05	616.90	695.78	774.67	853.46	932.34	1011.23	

Sample Item Number 4246BK3040 = Series 4246, Color Black, Size 3'0" wide x 4'0" high

Series 4256 - 1" Pickets

Price Code: L11

		OPENING WIDTH															
		1-1/2" Perimeter Frame								2" Perimeter Frame							
HEIGHT	Nominal	Actual	3'	4'	5'	6'	7'	8'	9'	10'	12'	14'	16'	18'	20'	22'	24'
	4'0"	46"	108.48	133.30	158.11	182.96	207.78	232.59	257.44	313.18	367.64	422.07	476.53	530.99	585.36	639.82	694.28
5'0"	58"	124.01	153.13	182.24	211.39	240.50	269.62	298.76	361.21	424.26	487.29	550.35	613.40	676.37	739.43	802.49	
6'0"	70"	139.54	172.95	206.37	239.81	273.23	306.64	340.08	409.23	480.88	552.51	624.16	695.82	767.38	839.04	910.70	
7'0"	82"	155.07	192.78	230.50	268.24	305.95	343.67	381.41	457.25	537.50	617.73	697.98	778.23	858.40	938.65	1018.90	
8'0"	94"	170.60	212.61	254.62	296.67	338.68	380.69	422.73	505.27	594.12	682.94	771.80	860.65	949.41	1038.26	1127.11	
10'0"	118"	201.66	252.27	302.88	353.52	404.13	454.74	505.38	601.31	707.36	813.38	919.43	1025.48	1131.43	1237.48	1343.53	

Sample Item Number 4256BK8060 = Series 4256, Color Black, Size 8'0" wide x 6'0" high

Apache Commercial Gate Options

- Trussing: It is recommended that trussing be used on gates over 12' wide or 6' high. See page 33.

Regency Commercial Fence, 4-5/8" Picket Centers

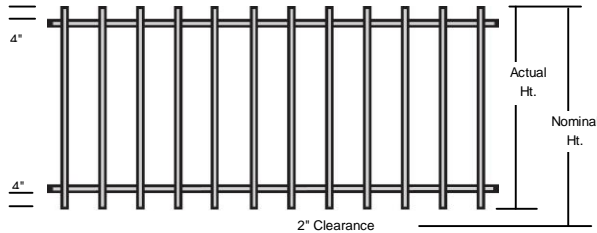

Frame: 1-1/2" Square Top and Bottom Rail, 14 Ga.
Pickets: 3/4" or 1" Pickets, 16 Gauge
 4-5/8" Picket Centers
Finish: Black Powder Coat - Standard
 Optional Colors Available

Series 2340 - 3/4" Pickets

Price Code: L11

		WIDTH				
HEIGHT	Nominal	Actual	8'-0" (94")	10'-0" (118")	12'-0" (142")	Custom Sizes
	3'0"	34"	\$184.10	\$226.62	\$269.21	Call for quote.
	3'6"	40"	\$201.50	\$248.34	\$295.24	
	4'0"	46"	\$218.90	\$270.05	\$321.24	
	5'0"	58"	\$253.71	\$313.46	\$449.53	
	6'0"	70"	\$288.53	\$433.37	\$517.37	
	7'0"	82"	\$394.71	\$489.91	\$585.17	
	8'0"	94"	\$439.96	\$546.43	\$652.98	
	10'0"	118"	\$530.46	\$659.51	\$788.60	

Sample Item Number 2340BK8036 = Series 2340, Color Black, Size 8'0" wide x 3'6" high

Series 2350 - 1" Pickets

Price Code: L11

		WIDTH				
HEIGHT	Nominal	Actual	8'-0" (94")	10'-0" (118")	12'-0" (142")	Custom Sizes
	3'0"	32"	\$203.32	\$250.52	\$297.79	Call for quote.
	3'6"	38"	\$224.11	\$276.46	\$328.86	
	4'0"	44"	\$244.91	\$302.39	\$359.90	
	5'0"	56"	\$286.50	\$354.23	\$498.28	
	6'0"	68"	\$328.11	\$482.58	\$576.20	
	7'0"	80"	\$441.07	\$547.55	\$654.10	
	8'0"	92"	\$493.10	\$612.50	\$731.99	
	10'0"	116"	\$597.17	\$742.46	\$887.78	

Sample Item Number 2350BK8036 = Series 2350, Color Black, Size 8'0" wide x 3'6" high

Regency Commercial Fence Options (Product Line: Z9999)

- 1-1/2" x 2" Top and Bottom Rails OP-RAIL-TO1.5X2 Add \$2.25 per lineal foot.
- 2" x 2" Top and Bottom Rails OP-RAIL-1.5TO2 Add \$2.50 per lineal foot.

COMMERCIAL GATES

Product Line G3844

Regency Commercial Gate, 4-5/8" Picket Centers

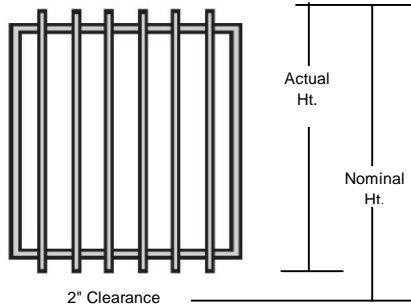

- Frame:** 1-1/2" Square Frame, 14 Ga. - 3' to 9' Width
2" Square Frame, 14 Ga. - 10' to 24' Width
Hardware not included
- Pickets:** 3/4" or 1" Vertical Pickets, 16 Gauge
4-5/8" Picket Centers
- Finish:** Black Powder Coat - Standard
Optional Colors Available

Series 4340 - 3/4" Pickets

Price Code: L11

		OPENING WIDTH															
		1-1/2" Perimeter Frame								2" Perimeter Frame							
HEIGHT	Nominal	Actual	3'	4'	5'	6'	7'	8'	9'	10'	12'	14'	16'	18'	20'	22'	24'
	3'0"	34"	95.87	117.21	138.40	159.73	181.05	202.26	223.60	273.44	320.83	368.15	415.62	530.00	584.88	639.77	694.77
4'0"	46"	111.74	137.37	162.87	188.52	214.14	239.65	265.30	321.85	377.86	504.06	570.36	636.51	702.68	768.85	835.12	
5'0"	58"	127.61	157.55	187.36	217.30	247.24	277.05	306.99	370.26	510.59	588.03	665.59	743.03	820.47	897.91	975.47	
6'0"	70"	143.46	177.71	211.84	246.09	280.31	314.44	416.75	494.50	583.27	672.00	760.83	849.56	938.26	1026.99	1115.82	
7'0"	82"	159.33	197.89	236.31	274.87	313.41	422.46	470.11	555.91	655.97	755.96	856.06	956.06	1056.06	1156.06	1256.17	
8'0"	94"	175.20	218.05	260.78	303.65	417.00	470.18	523.47	617.29	728.64	839.91	951.32	1062.58	1173.87	1285.14	1396.53	

Sample Item Number 4340BK12040 = Series 4340, Color Black, Size 12'0" wide x 4'0" high

Series 4350 - 1" Pickets

Price Code: L11

		OPENING WIDTH															
		1-1/2" Perimeter Frame								2" Perimeter Frame							
HEIGHT	Nominal	Actual	3'	4'	5'	6'	7'	8'	9'	10'	12'	14'	16'	18'	20'	22'	24'
	4'0"	46"	119.22	148.01	176.68	205.49	234.28	262.95	291.76	351.48	413.82	476.07	538.48	600.73	663.01	725.29	787.66
5'0"	58"	137.05	170.97	204.78	238.71	272.63	306.44	340.37	407.62	480.21	552.74	625.39	697.92	770.45	842.98	915.63	
6'0"	70"	154.84	193.91	232.85	271.92	310.96	349.90	388.97	463.76	546.60	629.41	712.31	795.12	877.89	960.70	1043.60	
7'0"	82"	172.67	216.87	260.93	305.13	349.31	393.39	437.57	519.90	613.02	706.07	799.22	892.28	985.34	1078.40	1171.57	
8'0"	94"	190.49	239.81	289.00	338.35	387.66	436.85	486.17	576.01	679.41	782.71	886.17	989.47	1092.81	1196.12	1299.54	
10'0"	118"	226.11	285.70	345.18	404.74	464.33	523.81	583.37	688.29	812.21	936.04	1060.00	1183.86	1307.70	1431.53	1555.51	

Sample Item Number 4350BK8060 = Series 4350, Color Black, Size 8'0" wide x 6'0" high

Regency Commercial Gate Options

- Trussing: It is recommended that trussing be used on gates over 12' wide or 6' high. See page 33.

(909) 379-0123 - Fax: (909) 379-0169 - Toll Free (866) 629-6636 - www.superior-bp.com

Regency Commercial Fence, 6" Picket Centers

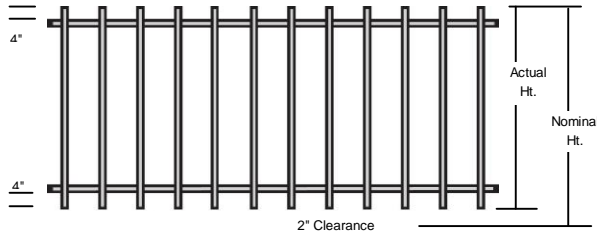

Frame: 1-1/2" Square Top and Bottom Rail, 14 Ga.
Pickets: 3/4" or 1" Pickets, 16 Gauge
 6" Picket Centers
Finish: Black Powder Coat - Standard
 Optional Colors Available

Series 2346 - 3/4" Pickets

Price Code: L11

		WIDTH				
HEIGHT	Nominal	Actual	8'-0" (94")	10'-0" (118")	12'-0" (142")	Custom Sizes
	3'0"	34"	\$162.74	\$199.78	\$236.85	Call for quote.
	3'6"	40"	\$177.64	\$218.31	\$259.07	
	4'0"	46"	\$192.51	\$236.87	\$281.29	
	5'0"	58"	\$222.30	\$273.96	\$401.96	
	6'0"	70"	\$252.06	\$387.56	\$462.16	
	7'0"	82"	\$353.20	\$437.76	\$522.38	
	8'0"	94"	\$393.43	\$487.96	\$582.57	
	10'0"	118"	\$473.85	\$588.39	\$702.99	

Sample Item Number 2346BK8036 = Series 2346, Color Black, Size 8'0" wide x 3'6" high

Series 2356 - 1" Pickets

Price Code: L11

		WIDTH				
HEIGHT	Nominal	Actual	8'-0" (94")	10'-0" (118")	12'-0" (142")	Custom Sizes
	3'0"	32"	\$177.76	\$218.41	\$259.08	Call for quote.
	3'6"	38"	\$195.31	\$240.23	\$285.23	
	4'0"	44"	\$212.83	\$262.07	\$311.37	
	5'0"	56"	\$247.93	\$305.74	\$363.64	
	6'0"	68"	\$282.99	\$349.43	\$415.90	
	7'0"	80"	\$318.06	\$393.09	\$468.19	
	8'0"	92"	\$353.15	\$436.76	\$520.45	
	10'0"	116"	\$423.29	\$524.12	\$625.01	

Sample Item Number 2356BK8036 = Series 2356, Color Black, Size 8'0" wide x 3'6" high

Regency Commercial Fence Options (Product Line: Z9999)

- 1-1/2" x 2" Top and Bottom Rails OP-RAIL-TO1.5X2 Add \$2.25 per lineal foot.
- 2" x 2" Top and Bottom Rails OP-RAIL-1.5TO2 Add \$2.50 per lineal foot.

COMMERCIAL GATES

Product Line G3844

Regency Commercial Gate, 6" Picket Centers

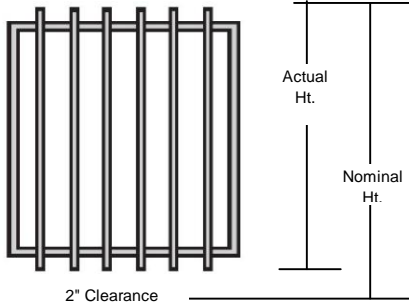

- Frame:** 1-1/2" Square Frame, 14 Ga. - 3' to 9' Width
2" Square Frame, 14 Ga. - 10' to 24' Width
Hardware not included
- Pickets:** 3/4" or 1" Vertical Pickets, 16 Gauge
6" Picket Centers
- Finish:** Black Powder Coat - Standard
Optional Colors Available

Series 4346 - 3/4" Pickets

Price Code: L11

		OPENING WIDTH															
		1-1/2" Perimeter Frame								2" Perimeter Frame							
HEIGHT	Nominal	Actual	3'	4'	5'	6'	7'	8'	9'	10'	12'	14'	16'	18'	20'	22'	24'
		3'0"	34"	88.35	106.89	125.43	144.05	162.58	181.12	199.68	246.81	288.70	330.57	372.52	414.41	456.28	498.18
	4'0"	46"	102.45	124.65	146.85	169.13	191.33	213.53	235.75	288.94	338.16	387.36	436.63	485.85	535.05	584.27	633.54
	5'0"	58"	116.55	142.41	168.27	194.22	220.08	245.94	271.83	331.08	387.62	444.14	500.75	557.29	613.81	670.36	726.96
	6'0"	70"	130.65	160.17	189.70	219.30	248.83	278.35	307.90	373.21	437.08	500.93	564.86	628.73	692.58	756.45	820.38
	7'0"	82"	144.74	177.93	211.12	244.39	277.58	310.76	343.97	415.35	486.54	557.72	628.97	700.17	771.34	842.54	913.79
	8'0"	94"	158.84	195.69	232.54	269.47	306.32	343.18	380.05	457.48	536.01	614.50	693.08	771.61	850.10	928.62	1007.21

Sample Item Number 4346BK12040 = Series 4346, Color Black, Size 12'0" wide x 4'0" high

Series 4356 - 1" Pickets

Price Code: L11

		OPENING WIDTH															
		1-1/2" Perimeter Frame								2" Perimeter Frame							
HEIGHT	Nominal	Actual	3'	4'	5'	6'	7'	8'	9'	10'	12'	14'	16'	18'	20'	22'	24'
		4'0"	46"	107.94	132.58	157.21	181.94	206.58	231.21	255.88	311.50	365.60	419.67	473.83	527.93	582.00	636.10
	5'0"	58"	123.47	152.41	181.34	210.37	239.30	268.24	297.20	359.53	422.22	484.89	547.65	610.34	673.01	735.71	798.47
	6'0"	70"	139.00	172.23	205.47	238.79	272.03	305.26	338.52	407.55	478.84	550.11	621.46	692.76	764.02	835.32	906.68
	7'0"	82"	154.53	192.06	229.60	267.22	304.75	342.29	379.85	455.57	535.46	615.33	695.28	775.17	855.04	934.93	1014.88
	8'0"	94"	170.06	211.89	253.72	295.65	337.48	379.31	421.17	503.59	592.08	680.54	769.10	857.59	946.05	1034.54	1123.09
	10'0"	118"	201.12	251.55	301.98	352.50	402.93	453.36	503.82	599.63	705.32	810.98	916.73	1022.42	1128.07	1233.76	1339.51

Sample Item Number 4356BK8060 = Series 4356, Color Black, Size 8'0" wide x 6'0" high

Regency Commercial Gate Options

- Trussing: It is recommended that trussing be used on gates over 12' wide or 6' high. See page 33.

COMMERCIAL FENCING

Product Line G3844

Sentry Commercial Fence, 4-5/8" Picket Centers

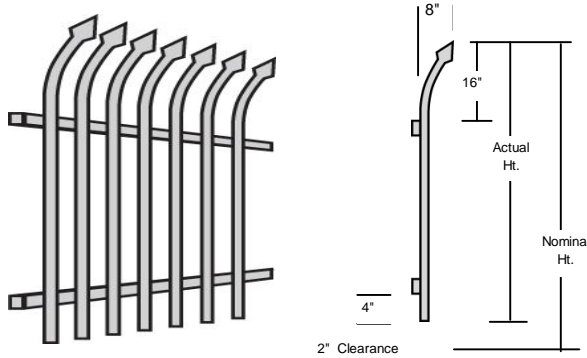

- Frame:** 1-1/2" Square Top and Bottom Rail, 14 Ga.
- Pickets:** 3/4" or 1" Pickets, 16 Gauge
4-5/8" Picket Centers
- Finish:** Black Powder Coat - Standard
Optional Colors Available

Series 2740 - 3/4" Pickets

Price Code: L11

		WIDTH				
HEIGHT	Nominal	Actual	8'-0" (94")	10'-0" (118")	12'-0" (142")	Custom Sizes
	6'0"	68"	\$301.01	\$448.85	\$535.85	Call for quote.
	7'0"	80"	\$407.19	\$505.39	\$603.65	
	8'0"	92"	\$452.44	\$561.91	\$671.46	
	9'0"	106"	\$497.69	\$618.45	\$739.27	
	10'0"	116"	\$542.94	\$674.99	\$807.08	

Sample Item Number 2740BK8060 = Series 2740, Color Black, Size 8'0" wide x 6'0" high

Series 2750 - 1" Pickets

Price Code: L11

		WIDTH				
HEIGHT	Nominal	Actual	8'-0" (94")	10'-0" (118")	12'-0" (142")	Custom Sizes
	6'0"	70"	\$340.59	\$421.57	\$502.65	Call for quote.
	7'0"	82"	\$382.18	\$473.44	\$564.76	
	8'0"	94"	\$423.77	\$525.28	\$626.88	
	9'0"	106"	\$465.36	\$577.15	\$688.99	
	10'0"	118"	\$506.95	\$629.01	\$751.11	

Sample Item Number 2750BK8060 = Series 2750, Color Black, Size 8'0" wide x 6'0" high

Sentry Commercial Fence Options (Product Line: Z9999)

- 1-1/2" x 2" Top and Bottom Rails OP-RAIL-TO1.5X2 Add \$2.25 per lineal foot.
- 2" x 2" Top and Bottom Rails OP-RAIL-1.5TO2 Add \$2.50 per lineal foot.

COMMERCIAL GATES

Product Line G3844

Sentry Commercial Gate, 4-5/8" Picket Centers

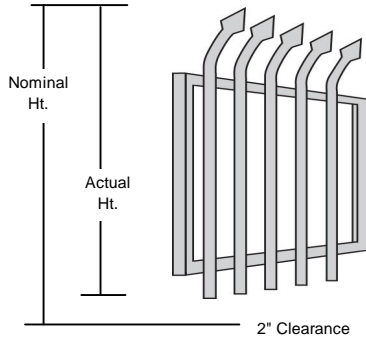

- Frame:** 1-1/2" Square Frame, 14 Ga. - 3' to 9' Width
2" Square Frame, 14 Ga. - 10' to 24' Width
Hardware not included
- Pickets:** 3/4" or 1" Vertical Pickets, 16 Gauge
Sentry Curved Top Apache Pickets
4-5/8" Picket Centers
- Finish:** Black Powder Coat - Standard
Optional Colors Available

Series 4740 - 3/4" Pickets

Price Code: L11

		OPENING WIDTH															
		1-1/2" Perimeter Frame							2" Perimeter Frame								
HEIGHT	Nominal	Actual	3'	4'	5'	6'	7'	8'	9'	10'	12'	14'	16'	18'	20'	22'	24'
	6'0"	7'0"	143.10	178.84	214.53	250.28	286.01	321.63	425.50	502.36	594.12	685.91	777.74	869.47	961.24	1053.03	1144.86
7'0"	8'2"	158.97	199.03	239.00	279.06	319.10	429.65	478.86	563.76	666.82	769.88	872.98	975.98	1079.03	1182.09	1285.21	
8'0"	9'4"	174.84	219.19	263.48	307.85	422.70	477.37	532.23	625.15	739.50	853.82	968.23	1082.50	1196.85	1311.17	1425.56	
9'0"	10'6"	190.71	239.37	287.97	404.36	464.77	525.09	585.59	686.56	812.18	937.79	1063.47	1189.03	1314.64	1440.26	1565.93	
10'0"	11'8"	206.56	259.53	312.44	440.78	506.87	572.83	638.96	747.97	884.87	1021.76	1158.70	1295.55	1432.43	1569.32	1706.29	

Sample Item Number 4740BK12040 = Series 4740, Color Black, Size 12'0" wide x 4'0" high

Series 4750 - 1" Pickets

Price Code: L11

		OPENING WIDTH															
		1-1/2" Perimeter Frame							2" Perimeter Frame								
HEIGHT	Nominal	Actual	3'	4'	5'	6'	7'	8'	9'	10'	12'	14'	16'	18'	20'	22'	24'
	6'0"	7'0"	154.48	195.04	235.55	276.11	316.65	357.10	465.78	547.45	648.85	750.27	851.72	953.09	1054.48	1155.90	1257.36
7'0"	8'2"	172.30	218.01	263.62	309.33	355.00	471.20	526.05	616.59	730.93	845.27	959.64	1073.92	1188.26	1302.60	1417.00	
8'0"	9'4"	190.13	240.94	291.70	342.54	463.85	524.99	586.31	685.70	812.98	940.24	1067.58	1194.78	1322.06	1449.32	1576.64	
9'0"	10'6"	207.95	263.90	319.80	443.47	511.18	578.79	646.58	754.84	895.04	1035.24	1175.50	1315.64	1455.84	1596.04	1736.30	
10'0"	11'8"	225.75	286.84	347.87	484.33	558.53	632.61	706.85	823.98	977.12	1130.24	1283.41	1436.50	1589.61	1742.73	1895.94	

Sample Item Number 4750BK8060 = Series 4750, Color Black, Size 8'0" wide x 6'0" high

Sentry Commercial Gate Options

- Trussing: It is recommended that trussing be used on gates over 12' wide or 6' high. See page 33.

Sentry Commercial Fence, 6" Picket Centers

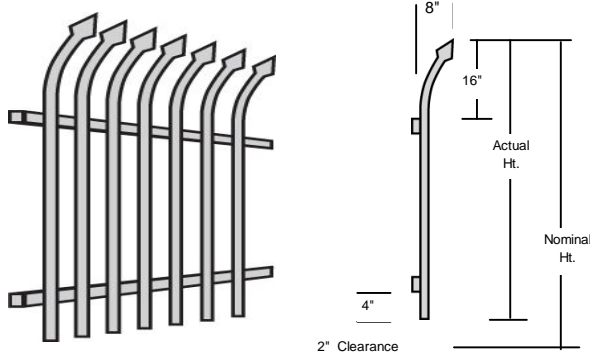

- Frame:** 1-1/2" Square Top and Bottom Rail, 14 Ga.
- Pickets:** 3/4" or 1" Pickets, 16 Gauge
6" Picket Centers
- Finish:** Black Powder Coat -Standard
Optional Colors Available

Series 2746 - 3/4" Pickets

Price Code: L11

		WIDTH				
HEIGHT	Nominal	Actual	8'-0" (94")	10'-0" (118")	12'-0" (142")	Custom Sizes
	6'0"	68"	\$264.12	\$326.07	\$388.00	Call for quote.
	7'0"	80"	\$293.89	\$363.17	\$432.44	
	8'0"	92"	\$323.68	\$400.26	\$476.86	
	9'0"	106"	\$353.44	\$437.37	\$521.28	
	10'0"	116"	\$383.21	\$474.46	\$565.72	

Sample Item Number 2746BK8060 = Series 2746, Color Black, Size 8'0" wide x 6'0" high

Series 2756 - 1" Pickets

Price Code: L11

		WIDTH				
HEIGHT	Nominal	Actual	8'-0" (94")	10'-0" (118")	12'-0" (142")	Custom Sizes
	6'0"	70"	\$295.05	\$364.43	\$433.78	Call for quote.
	7'0"	82"	\$330.12	\$408.09	\$486.07	
	8'0"	94"	\$365.21	\$451.76	\$538.33	
	9'0"	106"	\$400.28	\$495.45	\$590.60	
	10'0"	118"	\$435.35	\$539.12	\$642.89	

Sample Item Number 2756BK8060 = Series 2756, Color Black, Size 8'0" wide x 6'0" high

Sentry Commercial Fence Options (Product Line: Z9999)

- 1-1/2" x 2" Top and Bottom Rails OP-RAIL-T01.5X2 Add \$2.25 per lineal foot.
- 2" x 2" Top and Bottom Rails OP-RAIL-1.5T02 Add \$2.50 per lineal foot.

COMMERCIAL GATES

Product Line G3844

Sentry Commercial Gate, 6" Picket Centers

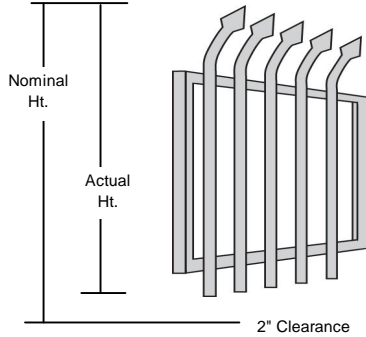

- Frame:** 1-1/2" Square Frame, 14 Ga. - 3' to 9' Width
2" Square Frame, 14 Ga. - 10' to 24' Width
Hardware not included
- Pickets:** 3/4" or 1" Vertical Pickets, 16 Gauge
Sentry Curved Top Apache Pickets
6" Picket Centers
- Finish:** Black Powder Coat - Standard
Optional Colors Available

Series 4746 - 3/4" Pickets

Price Code: L11

		OPENING WIDTH															
		1-1/2" Perimeter Frame								2" Perimeter Frame							
HEIGHT	Nominal	Actual	3'	4'	5'	6'	7'	8'	9'	10'	12'	14'	16'	18'	20'	22'	24'
	6'0"	7'0"	130.16	161.12	192.15	223.20	254.16	285.19	316.23	380.53	447.34	514.19	580.99	647.80	714.53	781.40	848.21
7'0"	8'2"	144.26	178.88	213.57	248.28	282.91	317.60	352.31	422.66	496.80	570.97	645.11	719.24	793.30	867.49	941.63	
8'0"	9'4"	158.35	196.64	235.00	273.37	311.66	350.01	388.38	464.80	546.26	627.76	709.22	790.68	872.06	953.58	1035.04	
9'0"	10'6"	172.45	214.41	256.42	298.45	340.41	382.42	424.46	506.94	595.72	684.55	773.33	862.12	950.82	1039.67	1128.46	
10'0"	11'8"	186.55	232.17	277.84	323.54	369.16	414.83	460.53	549.07	645.18	741.33	837.45	933.56	1029.59	1125.76	1221.87	

Sample Item Number 4746BK12060 = Series 4746, Color Black, Size 12'0" wide x 6'0" high

Series 4756 - 1" Pickets

Price Code: L11

		OPENING WIDTH															
		1-1/2" Perimeter Frame								2" Perimeter Frame							
HEIGHT	Nominal	Actual	3'	4'	5'	6'	7'	8'	9'	10'	12'	14'	16'	18'	20'	22'	24'
	6'0"	7'0"	138.51	173.19	207.92	242.69	277.36	312.10	346.86	414.86	489.10	563.36	637.60	711.83	785.98	860.28	934.51
7'0"	8'2"	154.04	193.02	232.05	271.11	310.09	349.12	388.18	462.88	545.72	628.58	711.42	794.25	876.99	959.89	1042.72	
8'0"	9'4"	169.57	212.84	256.18	299.54	342.81	386.14	429.51	510.91	602.34	693.80	785.23	876.66	968.00	1059.50	1150.93	
9'0"	10'6"	185.10	232.67	280.30	327.97	375.54	423.17	470.83	558.93	658.96	759.02	859.05	959.08	1059.02	1159.11	1259.14	
10'0"	11'8"	200.63	252.50	304.43	356.39	408.26	460.19	512.15	606.95	715.58	824.23	932.86	1041.49	1150.03	1258.72	1367.35	

Sample Item Number 4756BK8060 = Series 4756, Color Black, Size 8'0" wide x 6'0" high

Sentry Commercial Gate Options

- Trussing: It is recommended that trussing be used on gates over 12' wide or 6' high. See page 33.

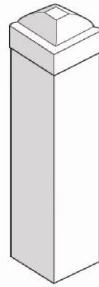

POSTS

Product Line: G8300

Post: 1-1/2" to 4" Square Post
Standard: Post without flange
With Pressed Steel Cap

Finish: Black Powder Coat - Standard
Optional Colors Available

Price Code: L11

PRICES (Per Each) BY POST TYPE

HEIGHT	Nominal	Actual	Series P1516	Series P1514	Series PG1514	Series P2014	Series PG2014	Series P2511
			1-1/2" Square 16 Gauge	1-1/2" Square 14 Gauge	Galvanized 1-1/2" Square 14 Gauge	2" Square 14 Gauge	Galvanized 2" Square 14 Gauge	2.5" Square 11 Gauge
			Price Each	Price Each	Price Each	Price Each	Price Each	Price Each
3'0"	36"	\$9.50	\$10.00	\$17.50	\$13.00	\$20.50	\$43.10	
3'6"	42"	\$10.50	\$11.50	\$19.60	\$15.00	\$23.55	\$49.40	
4'0"	48"	\$12.00	\$13.00	\$22.40	\$17.00	\$26.60	\$55.70	
4'6"	54"	\$13.00	\$14.50	\$24.50	\$19.00	\$29.65	\$62.00	
5'0"	60"	\$14.50	\$16.50	\$27.30	\$21.00	\$32.70	\$68.35	
5'6"	66"	\$16.00	\$18.00	\$29.40	\$29.40	\$35.75	\$74.65	
6'0"	72"	\$17.00	\$19.50	\$33.60	\$25.50	\$38.80	\$80.95	
6'6"	78"	\$18.00	\$21.00	\$34.30	\$27.50	\$41.85	\$87.25	
7'0"	84"	\$19.50	\$22.50	\$37.15	\$33.74	\$44.90	\$93.60	
7'6"	90"	\$21.00	\$24.50	\$39.70	\$31.50	\$47.95	\$99.90	
8'0"	96"	\$22.50	\$26.00	\$42.25	\$36.41	\$51.00	\$106.20	
9'0"	108"	\$25.00	\$29.00	\$47.35	\$37.50	\$57.00	\$118.85	
10'0"	120"	\$28.00	\$32.50	\$52.45	\$42.00	\$63.20	\$131.45	

Sample Item Number P1516BK40 = Series P1516, Color Black, Size 4'0" high

PRICES BY POST TYPE

HEIGHT	Nominal	Actual	Series P3011	Series P4011	Series P4025
			3" Sq. 11 Ga.	4" Sq. 11 Ga.	4" Sq. .250"
			Price Each	Price Each	Price Each
5'0"	60"	\$80.10	\$119.10	\$208.85	
5'6"	66"	\$87.40	\$130.15	\$228.75	
6'0"	72"	\$94.70	\$141.20	\$248.70	
6'6"	78"	\$102.00	\$152.25	\$268.65	
7'0"	84"	\$109.35	\$163.35	\$288.60	
7'6"	90"	\$116.65	\$174.40	\$308.50	
8'0"	96"	\$123.95	\$185.45	\$328.45	
9'0"	108"	\$138.60	\$207.60	\$368.35	
10'0"	120"	\$153.20	\$229.75	\$395.00	
11'0"	132"	\$167.70	\$218.75	\$446.35	
12'0"	144"	\$186.10	\$273.35	\$487.90	

Flange Welded to Post

Product Line: Z9999

Posts with flange will be 1" longer than nominal.

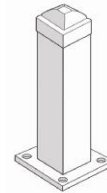

Add to Cost of Post

Flange - 4" x 4" x 3/16"

OP-4X4FLANGE

\$4.93

Flange - 6" x 6" x 1/4"

OP-6X6FLANGE

\$11.18

Other Attachment and Preparation Options

Product Line: Z9999

Post drilled for strike bolt

OP-DRILL4STRK

\$2.64

Post welded to panel

OP-WELD1SIDE

\$5.28











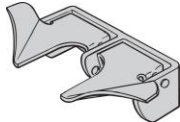
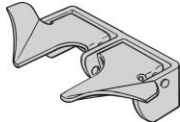

Post welded in center of 2 panels

OP-WELD2SIDE

\$6.60

Hardware

Price Code: L11

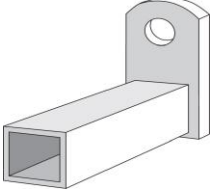
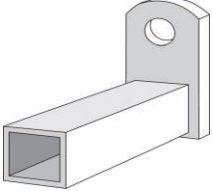
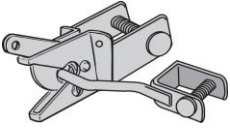
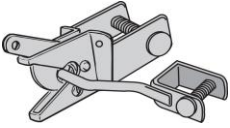
Individual Parts			Installed by SBP		
Product Line: G8200			Product Line: Z9999		
Part No.	Description	Price Each	Option Code	Price Each	
8212	Single Gate Hardware Kit (not shown) Contents: 1 Gravity latch, 2 Base Plates, 2 Hanger Bolts, 8 Mounting Screws	\$23.75	OP-INSTL8212	\$25.30	
8213	Double Gate hardware Kit (not shown) Contents: 1 Gravity latch, 4 Base Plates, 4 Hanger Bolts, 14 Mounting Screws	\$43.13	OP-INSTL8213	\$46.20	
8214	Gate Hanger Bolt "J" Assy. 5/8"	\$5.63	OP-INSTL8214	\$10.56	
8215	Gate Hanger Bolt "J" Assy. 1/2"	\$3.25	OP-INSTL8215	\$8.98	
8217	Gravity Latch - No Hole If installed, please specify: Weld gravity latch receiver to gate Weld gravity latch pin to gate	\$2.44	OP-INSTL8217 OP-REC2GATE OP-PIN2GATE	\$7.04	
8219	Butterfly Latch	\$16.25	OP-INSTL8219	\$20.24	
8220	Slide Bolt	\$4.06	OP-INSTL8220	\$5.68	
8222	9" Gate Spring - Black	\$10.94	OP-INSTL8222	\$11.66	
8223	12" Gate Spring - Black	\$19.38	OP-INSTL8223	\$14.74	
8225	12" Cane Bolt, 1/2" Diameter	\$9.38	OP-INSTL8225	\$10.56	
8226	18" Cane Bolt, 1/2" Diameter	\$10.00	OP-INSTL8226	\$10.56	
8227	24" Cane Bolt, 1/2" Diameter	\$13.13	OP-INSTL8227	\$13.86	
8542	Batwing 1" x 1" x 2", 5/8" Diameter	\$1.50	OP-INSTL8542	\$3.17	
8543	Batwing 1" x 1" x 2", 1/2" Diameter If installed, please specify: Weld batwing to post Weld batwing to tab	\$1.81	OP-INSTL8543 OP-BATWG2POST OP-BATWG2TAB	\$3.52	
8537	1" Fence Mounting Bracket 4/Pkg	\$15.31	N/A		
8539	1-1/2" Fence Mounting Bracket 4/Pkg	\$15.63	N/A		
		Price per Set			
8260	Post Size: 1-1/2", Gate Frame: 1"	\$17.50	N/A		
8261	Post Size: 2", Gate Frame: 1"	\$17.50	N/A		

Hinges

Price Code: L11

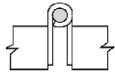
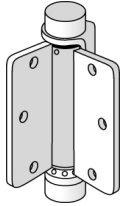
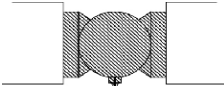
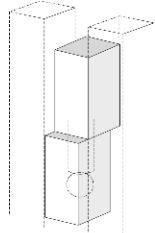
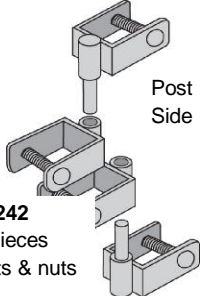
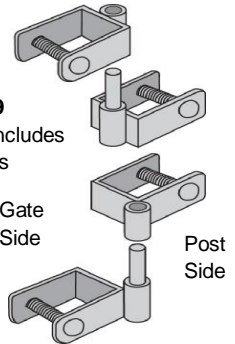
Individual Parts			Installed by SBP		
Part No.	Description	Price Each	Option Code	Price Each	
Product Line: G8660			Product Line: Z9999		
Butt Hinges					
8662	Butt hinge, Std. 3-1/2" x 2-1/4" x .125	\$2.35	OP-INSTL8662	\$5.98	 8665
8665	Butt hinge, Heavy 3" x 3" x .178	\$7.50	OP-INSTL8665	\$9.02	
8666	Butt hinge, Heavy 4" x 4" x .198	\$26.00	OP-INSTL8666	\$20.46	
8667	Butt hinge, Heavy 5" x 5" x .198	\$42.00	OP-INSTL8667	\$38.06	
8668	Butt hinge, Heavy 6" x 6" x .198	\$60.00	OP-INSTL8668	\$52.36	
8669	Self-Closing 3-1/2" x 3-1/2" Spring Hinge (Maximum door size recommended 3/0 x 7/0) For doors up to 70#, use 2 spring hinges and one butt hinge. For doors up to 90#, use 3 spring hinges.	\$58.00	OP-INSTL8669	\$65.56	 8669
Barrel Hinges					
8675	Ball Bearing - 5/8" Pin, 1-3/8" Clear, 5" Height	\$55.00	OP-INSTL8675	\$39.16	 8675
8677	Heavy Ball Bearing - 3/4" Pin, 1-1/2" Clear, 7" Height	\$39.00	OP-INSTL8677	\$44.66	
8680	Standard Barrel Hinge, 5/8" Pin	\$2.85	OP-INSTL8680	\$8.71	
Square Ball Bearing Hinges					
8682	1" Square Hinge - 1/2" Pin, 1-1/4" Clear, 4" Height	\$93.00	OP-INSTL8682	\$133.98	 8682
8684	1-1/2" Square Hinge - 5/8" Pin, 2" Clear, 6" Height	\$136.00	OP-INSTL8684	\$181.06	
Product Line: G8200					
Clamp-On Hinge (1/2" pin size)		Price per Set			 8240-8242 Set of 4 Pieces includes bolts & nuts
8240	Post Size: 1-1/2", Gate Frame: 1"	\$20.63	N/A		
8241	Post Size: 2", Gate Frame: 1"	\$21.25	N/A		
8242	Post Size: 2", Gate Frame: 1-1/2"	\$21.88	N/A		
One Way Auto Closing Hinge (1/2" pin size)		Price per Set			 8248-8249 Set of 4 Pieces includes bolts & nuts
8248	Post Size: 1-1/2", Gate Frame: 1"	\$20.94	N/A		
8249	Post Size: 2", Gate Frame: 1"	\$20.94	N/A		

Applications

Hinge Left (from outside) Hinge Right (from outside)	OP-HNGLEFT OP-HNGRIGHT	No charge
---	---------------------------	-----------

Rolling Gates

Price Code: L11

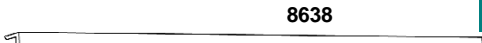
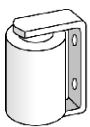
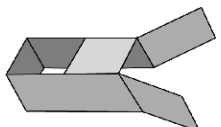
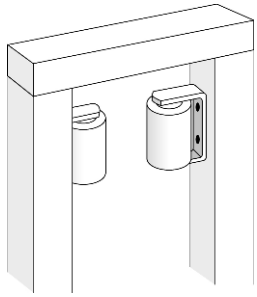
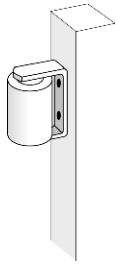
Individual Parts				
Part No.	Description	Product Line	Price Each	
8638	1" x 1" x 1/8" Angle x 20' Plain	G8805	\$53.20	
8640	1" x 1" x 1/8" Angle x 20' W/Tabs	G8630	\$120.50	
8642	1" x 1" x 1/8" Angle x 20' W/4" Plate	G8630	\$181.50	
8645	Rubber Guide Assembly 3"	G8630	\$13.00	
8646	Rubber Guide Assembly 6"	G8630	\$19.50	
8647	Gate End Guide	G8630	\$14.00	
Pre-Fab Guide Roller Assembly Welded on 2" 16 Ga. Post				
8650	3" Roller, Double Post up to 66"	G8630	\$106.00	
8652	3" Roller, Double Post up to 90"	G8630	\$121.00	
8651	6" Roller, Double Post up to 66"	G8630	\$124.20	
8653	6" Roller, Double Post up to 90"	G8630	\$139.00	
8655	3" Roller, Single Post up to 66"	G8630	\$51.00	
8657	3" Roller, Single Post up to 90"	G8630	\$59.00	
8656	6" Roller, Single Post up to 66"	G8630	\$60.00	
8658	6" Roller, Single Post up to 90"	G8630	\$68.00	

Sliding-Rolling Wheels

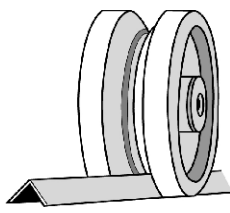
Individual Parts				
Part No.	Description	Product Line	Price Each	
8630	"V" Groove Wheel 4" x 1-1/2"	G8630	\$26.50	
8631	"V" Groove Wheel 6" x 2"	G8630	\$39.50	
8633	"V" Groove Wheel W/Box 4" x 1-1/2"	G8630	\$37.00	
8634	"V" Groove Wheel W/Box 6" x 2"	G8630	\$74.00	

Lock Boxes

Price Code: L11

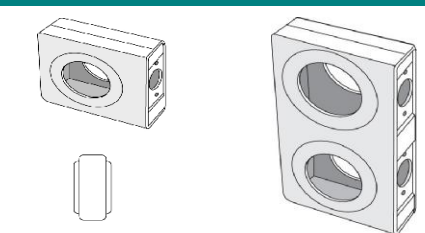
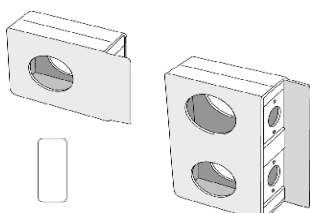
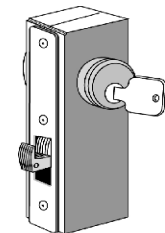
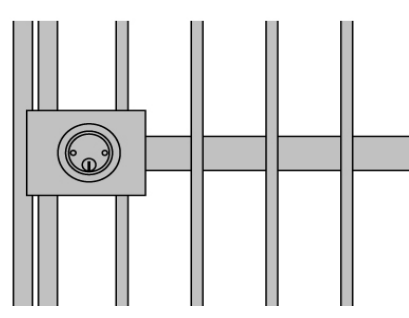
Description	Option Code	Installed Price	Unit	
1-1/4" D/Lock Box, Raised, W/Lip	OP-INSTL8557	\$24.11	/Each	 <p>8559, 8560</p>
1-1/4" S/Lock Box, Raised, W/Lip	OP-INSTL8558	\$21.34	/Each	
1-1/4" D/Lock Box, Raised, No Lip*	OP-INSTL8559	\$0.00	/Each	
1-1/4" S/Lock Box, Raised, No Lip*	OP-INSTL8560	\$0.00	/Each	
* Standard Lock Box used by Superior on products requiring Lock Boxes.				
1-5/8" D/Lock Box	OP-INSTL8563	\$23.76	/Each	 <p>8563 8564</p>
1-5/8" S/Lock Box	OP-INSTL8564	\$23.76	/Each	
Hook Lock Box Assembly (Kwikset Keyway)	OP-INSTL8081	\$59.81	/Each	 <p>8081</p>
When lockbox is utilized, it is recommended that 1" x 3/16" flat strap be installed horizontally and welded to each picket in order to prevent forced entry (see illustration).				
3/16" x 1" flat strap	OP-LOCKTRUSS	\$5.50	/Lin. Ft.	



CUSTOM GATE AND FENCING APPLICATIONS

Product Line: Z9999

Arching or Swooping on Gates or Panels

Price Code: L11

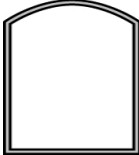
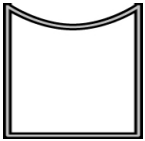
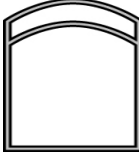
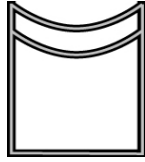
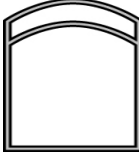
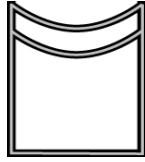
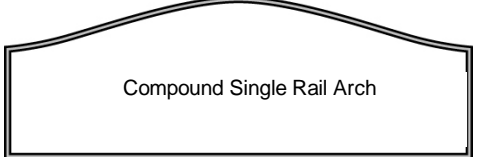
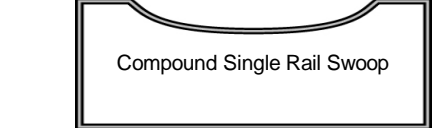
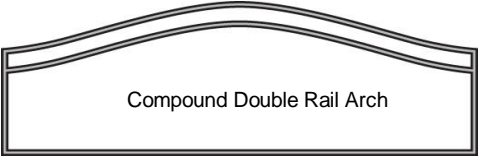
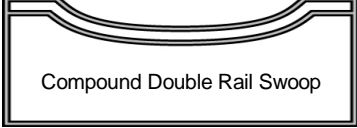
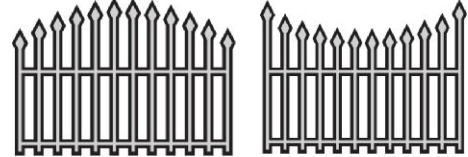
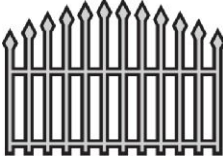
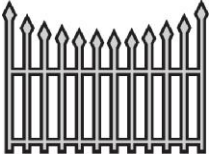
Description	Price per Lineal Foot ‡				
	1" Frame	1-1/2" Frame	2" Frame		
Simple Arching or Swooping Tops					
Single Rail Arch	OP-SSRARCH-1 \$10.00	OP-SSRARCH-1.5 \$11.65	OP-SSRARCH-2 \$12.95		
Single Rail Swoop	OP-SSRSWOOP-1 \$12.57	OP-SSRSWOOP-1.5 \$14.29	OP-SSRSWOOP-2 \$15.59		
Double Rail Arch	OP-SDRARCH-1 \$16.17	OP-SDRARCH-1.5 \$19.61	OP-SDRARCH-2 \$22.19		
Double Rail Swoop	OP-SDRSWOOP-1 \$16.17	OP-SDRSWOOP-1.5 \$19.61	OP-SDRSWOOP-2 \$22.19		
Compound Arching or Swooping Tops					
Compound Single Rail Arch	OP-CSRARCH-1 \$14.49	OP-CSRARCH-1.5 \$16.50	OP-CSRARCH-2 \$18.00		
Compound Single Rail Swoop	OP-CSRSWOOP-1 \$10.46	OP-CSRSWOOP-1.5 \$12.18	OP-CSRSWOOP-2 \$13.47		
Compound Double Rail Arch	OP-CDRARCH-1 \$25.56	OP-CDRARCH-1.5 \$29.56	OP-CDRARCH-2 \$32.58		
Compound Double Rail Swoop	OP-CDRSWOOP-1 \$19.96	OP-CDRSWOOP-1.5 \$20.40	OP-CDRSWOOP-2 \$22.98		
Arching or Swooping of Pickets					
Arching of Pickets Only	OP-PCKTARCH-1 \$10.31	OP-PCKTARCH-1.5 \$10.31	OP-PCKTARCH-2 \$10.31		
Swooping of Pickets Only	OP-PKTSWOOP-1 \$10.31	OP-PKTSWOOP-1.5 \$10.31	OP-PKTSWOOP-2 \$10.31		

‡ Minimum: 6 feet.

Note: Standard Arch or Swoop will equal 10% of width of Gate or Panel. Nominal height of panel is to shoulder.

Example: 10' Gate will arch or swoop 1' at centerpoint.

(909) 379-0123 - Fax: (909) 379-0169 - Toll Free (866) 629-6636 - www.superior-bp.com



CUSTOM GATE AND FENCING APPLICATIONS

Product Line: Z9999

Double Drive Gates

Price Code: L11

Price per Lineal Foot (Minimum: 6 feet)				
1" Frame	1-1/2" Frame	2" Frame		
Compound Arching or Swooping Tops				
Compound Single Rail Arch --Double Drive				
OP-CSRRCHDD-1	OP-CSRRCHDD-1.5	OP-CSRRCHDD-2		
\$14.76	\$16.86	\$18.27		
Compound Single Rail Swoop --Double Drive				
OP-CSRSPDD-1	OP-CSRSPDD-1.5	OP-CSRSPDD-2		
\$10.46	\$12.18	\$13.47		
Compound Double Rail Arch--Double Drive				
OP-CDRRCHDD-1	OP-CDRRCHDD-1.5	OP-CDRRCHDD-2		
\$45.36	\$49.36	\$52.38		
Compound Double Rail Swoop--Double Drive				
OP-CDRSWPDD-1	OP-CDRSWPDD-1.5	OP-CDRSWPDD-2		
\$28.84	\$32.28	\$34.86		
Arching of Pickets Only				
OP-PKTRCHDD-1	OP-PKTRCHDD-1.5	OP-PKTRCHDD-2		
\$10.31	\$10.31	\$10.31		
Swooping of Pickets Only				
OP-PKTSWPDD-1	OP-PKTSWPDD-1.5	OP-PKTSWPDD-2		
\$10.31	\$10.31	\$10.31		
Double Top Rail Straight				
Double Top Rail Straight--Double Drive				
OP-DBLRALDD-1	OP-DBLRALDD-1.5	OP-DBLRALDD-2		
\$3.00	\$4.43	\$5.50		

Note: Standard Arch or Swoop will equal 10% of width of Gate or Panel. Nominal height of panel is to shoulder.
 Example: 10' Gate will arch or swoop 1' at centerpoint.







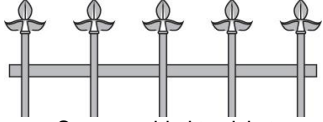
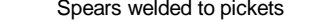
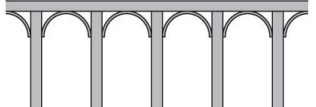
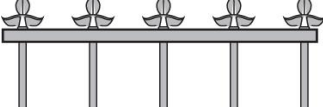

(909) 379-0123 - Fax: (909) 379-0169 - Toll Free (866) 629-6636 - www.superior-bp.com

CUSTOM GATE AND FENCING APPLICATIONS

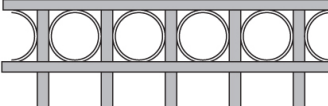
Product Line: Z9999

Installation of Special Applications

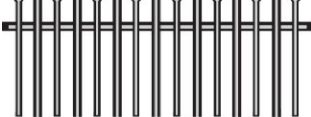
Price Code: L11

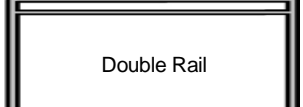
Application	Option Code	Price per Lineal Foot ‡		
Installed to Pickets				
Cast Spears Installed to Pickets	See Page 36			
Knuckle Every Picket ^Δ	OP-KNKLPKT	\$4.95		
Knuckle Every Other Picket ^Δ	OP-KNKLALTPKT	\$2.48		
2 Knuckles Every Picket ^Δ	OP-2KNKLPKT	\$9.90		
2 Knuckles Every Other Picket ^Δ	OP-2KNKLALTPKT	\$4.95		
Radius Arches Installed	OP-RADARCH	\$3.38		
Circles Installed To Picket**	OP-CIRCPKT	\$10.03		
Installed to Rail				
Cast Spears Installed to Rail	See Page 36			
Circles Installed to Rail**	OP-CIRCRAIL	\$8.71		
Scroll Installed To Rail	OP-SCROLLRAIL	\$4.75		
Application	Price per Lineal Foot ‡ (includes parts & labor)			
	1" Rail	1-1/2" Rail	2" Rail	
Installed Between Rails				
Circles Between Rails**	OP-CRCBTWRL-1 \$8.71	OP-CRCBTWRL-1.5 \$8.71	OP-CRCBTWRL-2 \$8.71	
Pickets Between Rails	OP-PKTBWRL-1 \$6.60	OP-PKTBWRL-1.5 \$6.60	OP-PKTBWRL-2 \$6.60	
Every Other Picket Between Rails	OP-ALPKBWRL-1 \$5.28	OP-ALPKBWRL-1.5 \$5.28	OP-ALPKBWRL-2 \$5.28	
Circles & Pickets Between Rails**	OP-CRPKBWRL-1 \$8.71	OP-CRPKBWRL-1.5 \$8.71	OP-CRPKBWRL-2 \$8.71	
Scroll Between Rails	OP-SCLBTWRL-1 \$3.38	OP-SCLBTWRL-1.5 \$3.38	OP-SCLBTWRL-2 \$3.38	
Staggered Pickets	OP-STAGPKT-1 \$7.92	OP-STAGPKT-1.5 \$7.92	OP-STAGPKT-2 \$7.92	
Double Rail	OP-DBLRAIL-1 \$8.28	OP-DBLRAIL-1.5 \$9.71	OP-DBLRAIL-2 \$10.79	

‡ Minimum: 6 feet.

^Δ Priced for 5/8" knuckle. Prices will vary for other sizes.

** Priced for 4" circles. Prices will vary for other sizes.

Special Panels

Fixed Biased Panel or Gate

When ordering biased panels or gates, specify the following:

1. Drop in inches or degrees. (A)
2. Measurement on slope. (B)

When ordering Apache or Regency style, specify which end of the panel or gate is the high end as viewed from outside of fence line. (Pickets are on outside.)

Add price per lineal foot. Minimum: 6 feet.

Fixed Biased Panel or Gate **OP-FIXBIAS** \$6.75

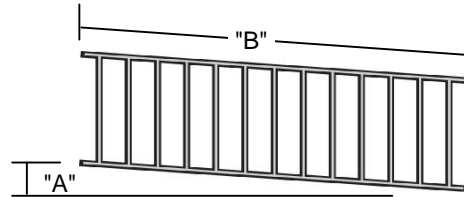

Curved Panels

When ordering curved panels or gates, you must give one of the following combinations of measurements:

1. Radius and measurement of the curve. ("A" & "B")
2. Deflection and measurement of the curve. ("C" & "B")

When ordering Apache or Regency style, specify if the pickets are on the inside or the outside of the curve.

Add price per lineal foot. Minimum: 6 feet.

Curved Panels **OP-CURVE** \$17.00

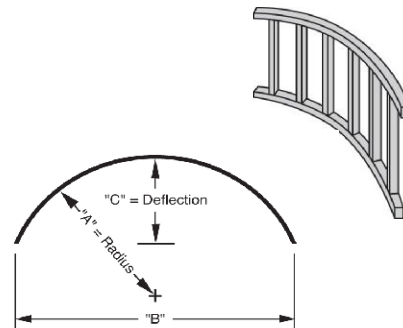

Tapered Panel or Gate

When ordering tapered panel or gate:

Specify which end is tallest. Specify which rail tapers as viewed from outside of fence line. (Pickets are on outside). Specify "A" and "B" dimension.

Add to special size price per lineal foot. Minimum: 6 feet.

Tapered Panel or Gate **OP-TAPER** \$13.50

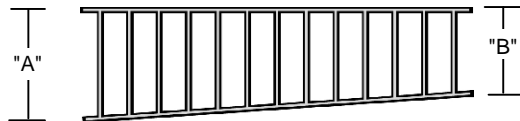

Notched Panel or Gate

When ordering notched panel or gate:

Specify location of notch as viewed from outside of fence line.

Specify height of notch.

Add to special price per notch.

Notched Panel or Gate **OP-NOTCH** \$40.00

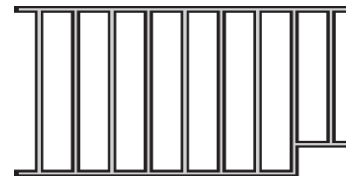

Doggie Pickets (up to 24" in height)

(1/8" x 1/2" or 1/8" x 1" Horizontal Support Standard)

Add price per lineal foot. Minimum: 6 feet.

Doggie Pickets (1/8" x 1/2" Support) **OP-DOGPKT-1/2** \$11.11

Doggie Pickets (1/8" x 1" Support) **OP-DOGPKT-1** \$11.94

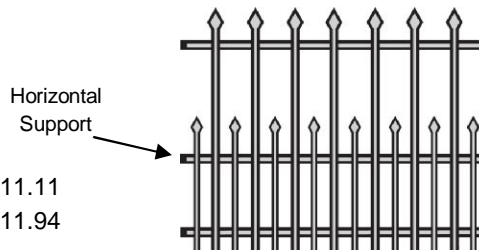



CUSTOM GATES AND FENCING APPLICATIONS

Product Line: Z9999

Rolling Gates

Price Code: L11

Description	Option Code	Installed Price	Unit
Wheel Box with Wheel (Completely enclosed and welded into gate.)			
4" V-Groove wheel assembly	OP-INSTL8633	\$47.30	/Each
6" V-Groove wheel assembly	OP-INSTL8634	\$80.30	/Each
Wheel Box Only (welded to gate)			
4" wheel box only	OP-WHLBOX4	\$26.62	/Each
6" wheel box only	OP-WHLBOX6	\$33.35	/Each
Electric Slide Gate Tail (welded to gate)			
Electric Slide Gate Tail (2' high x 3' long) is necessary on gates using an electric gate operator. It is used to supply additional length only.			
1-1/2" Square Tubular Tail	OP-GATETAIL-1.5	\$37.95	/Each
2" Square Tubular Tail	OP-GATETAIL-2	\$46.70	/Each
When ordering, specify which side of the gate requires a tail (left side or right side) as viewed from outside the fence line.			
Left side Tail	OP-LEFTTAIL		
Right side Tail	OP-RIGHTTAIL		
Outrigger Roller (welded to gate)			
Outrigger Spring Roller Assembly			
Used for added stability on swinging gates.			
Spring Roller Assembly	OP-INSTL8672	\$41.80	/Each

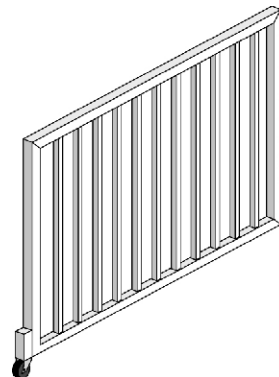
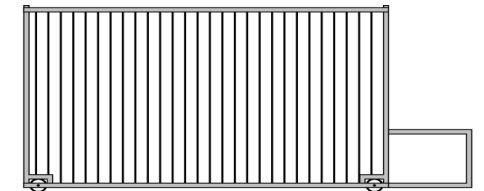
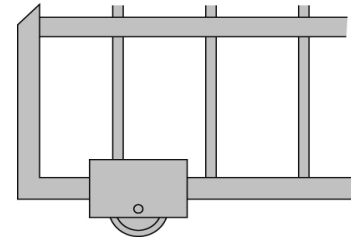



CUSTOM GATE AND FENCING APPLICATIONS

Product Line: Z9999

Trussing

Price Code: L11

Description	Option Code	Price	Unit
Trussing or Guide Strapping*			
3/4" square tubing	OP-TRUS8807	\$5.01	/Lin. Ft.
3/16" x 1" flat strap	OP-TRUS8835	\$5.50	/Lin. Ft.
3/16" x 2" flat strap	OP-TRUS8838	\$6.82	/Lin. Ft.
1/4" x 2" flat strap	OP-TRUS8842	\$10.12	/Lin. Ft.

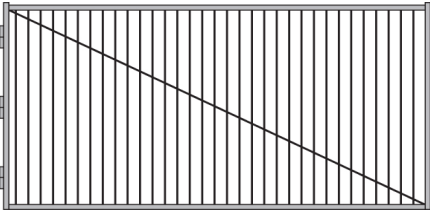

Diagonal Truss used on swing gates.

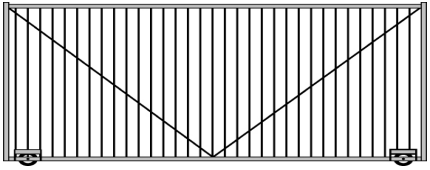





V-Truss used on rolling gates.

***Note:** It is recommended that trussing be used on gates over 12' wide or 6' high.
Recommended Trussing:
 Up to 16' wide or 8' high, use 1"
 Over 16' wide or 8' high, use 2"

Spear Types

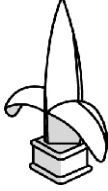
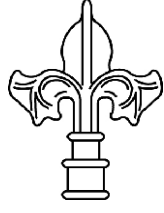
Price Code: L11

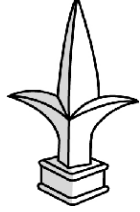
Description	Option Code	Spear Price Per Lineal Foot		
Country Club Spear 1/2"	OP-SPR8410	\$1.53		 Country Club
Country Club Spear 5/8"	OP-SPR8411	\$1.53		
Country Club Spear 3/4"	OP-SPR8412	\$1.70		
Country Club w/Ball 1/2"	OP-SPR8414	\$1.64	 Country Club w/ Ball	
Country Club w/Ball 5/8"	OP-SPR8415	\$2.23		
Country Club w/Ball 5/8" Heavy	OP-SPR8415H	\$2.82		
Country Club w/Ball 3/4"	OP-SPR8416	\$1.52		
Country Club w/Ball 3/4" Heavy	OP-SPR8416H	\$5.51		
Seville Spear 1/2"	OP-SPR8418	\$1.88		 Seville
Seville Spear 5/8"	OP-SPR8419	\$2.35		
Seville Spear 3/4"	OP-SPR8420	\$2.35		
Spanish Spear 1/2"	OP-SPR8422	\$4.22	 Spanish	
Spanish Spear 5/8"	OP-SPR8423	\$1.99		
Spanish Spear 5/8" Heavy	OP-SPR8423H	\$4.11		
Spanish Spear 3/4"	OP-SPR8424	\$2.23		
Spanish Spear 3/4" Heavy	OP-SPR8424H	\$5.28		
Classic Spear 1/2 "	OP-SPR8426	\$1.70		 Classic
Classic Spear 5/8 "	OP-SPR8427	\$1.64		
Classic Spear 5/8 " Heavy	OP-SPR8427H	\$3.05		
Classic Spear 3/4 "	OP-SPR8428	\$2.35		
Classic Spear 3/4" Heavy	OP-SPR8428H	\$4.22		
Florentine 5/8"	OP-SPR8430	\$2.70		 Florentine

Applications

Price Code: L11

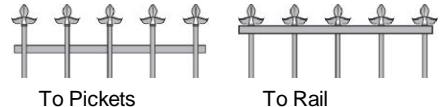
Description	Installed by SBP Option Code	Labor Price per Lineal Foot	
Spears Installed to Pickets	OP-SPRPKT	\$2.64	 To Pickets To Rail
Spears Installed to Rail	OP-SPRRAIL	\$5.28	
Spears Installed to Arched Pickets	OP-SPRPKT-ARCH	\$15.84	
Spears Installed to Arched Rail	OP-SPRRAIL-ARCH	\$15.84	









Note: Total Cost = (Spear Cost per Lineal Ft. + Labor Cost per Lineal Ft.) x # of Lineal Feet

Example: Install Classic Spear, 5/8" to Pickets on 6 ft. fence = (\$1.64+\$2.64) x 6' = \$25.68

(909) 379-0123 - Fax: (909) 379-0169 - Toll Free (866) 629-6636 - www.superior-bp.com

Ornamental Castings

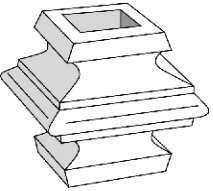
Price Code: L11



Description	Installed by SBP Option Code	Installed Price per Each		
Castings				
Granada Casting 8"x 17-1/2", 1/2"	OP-CAST8440	\$9.99		
Granada Casting 8" x 17-1/2", 5/8" - Alum.	OP-CAST8441	\$9.15		
Corsican Casting 7-1/2" x 13-7/8", 1/2"	OP-CAST8443	\$8.89	Granada	Corsican
Corsican Casting 7-1/2" x 13-7/8", 5/8"-Alum	OP-CAST8444	\$8.89		
Victoria Casting 6-3/4" x 15-1/4", 1/2"	OP-CAST8445	\$10.78		
Bird of paradise Casting 8-3/4" x 26-1/2"	OP-CAST8446	\$26.27		
Deco Casting 3-3/4" x 3-3/4", 5/8" -Alum	OP-CAST8456	\$5.94		Bird of Paradise
			Deco	
Ball Caps (Installed with tack welds.)				
Cast Iron Ball Caps 1-1/2"	OP-CAP8471	\$3.96		
Cast Iron Ball Caps 2"	OP-CAP8472	\$5.06		
Cast Iron Ball Caps 3"	OP-CAP8473	\$7.26		
Cast Iron Ball Caps 4"	OP-CAP8474	\$10.08		
Full weld installation of ball caps	OP-CAPFLWELD	\$2.64		
Knuckles				
Knuckles 5/8"	OP-KNKL8461	See pg. 30		
Knuckles 3/4"	OP-KNKL8462	Call for pricing		
Knuckles 1"	OP-KNKL8463	Call for pricing		
Circles				
Steel Tube Ring 4"	OP-CIRC8485	See pg. 30		
Steel Tube Ring 5"	OP-CIRC8488	Call for pricing		
Steel Tube Ring 6"	OP-CIRC8486	Call for pricing		

For individual uninstalled parts, please call SBP for pricing.

(909) 379-0123 - Fax: (909) 379-0169 - Toll Free (866) 629-6636 - www.superior-bp.com

Hand Rail Accessories

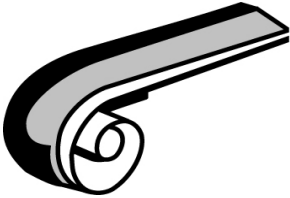
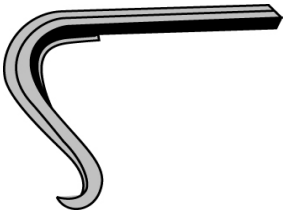
Price Code: L11

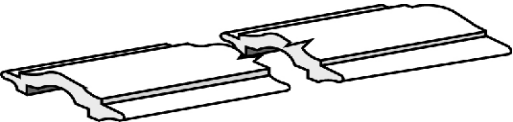
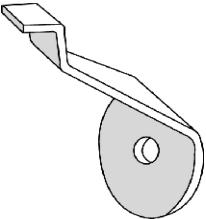
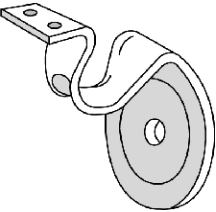
Description	Option Code	Installed Price per Each	
4" Standard Rail End	OP-INSTL8480	\$22.84	
5" Lambs Tongue	OP-INSTL8482	\$18.17	
5-1/2" Beveled Rail End	OP-INSTL8484	\$18.17	
1" CapRail 20'	OP-INSTL8487	\$8.14	
Handrail Bracket 3" Offset	OP-INSTL8532	\$11.36	
Handrail Bracket 3-1/2" Offset	OP-INSTL8533	\$5.28	

Tabs

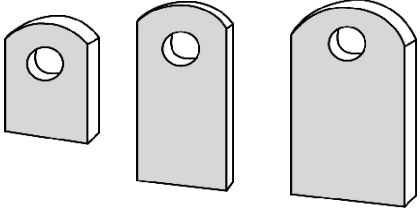
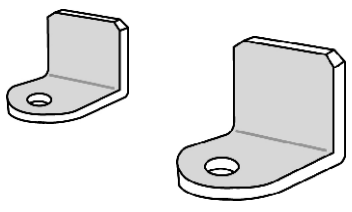
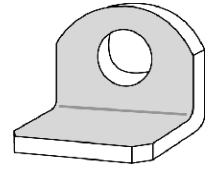
Description	Installed by SBP Option Code	Installed Price Per Each	
1" x 1-1/2" x 3/16" Tab with 3/8" Hole	OP-INSTL8500	\$1.54	
1" x 2-1/4" x 3/16" Tab with 3/8" Hole	OP-INSTL8501	\$1.67	
1-1/2" x 2-3/4" x 3/16" Tab with 3/8" Hole	OP-INSTL8503	\$1.67	
1-1/2" x 3/16" Stand-off Tab with 3/8" Hole	OP-INSTL8509	\$2.07	
2" x 3/16" Stand-off Tab with 3/8" Hole	OP-INSTL8510	\$2.20	
3" x 3/16" Stand-off Tab with 3/8" Hole	OP-INSTL8511	\$2.07	
4" x 3/16" Stand-off Tab with 3/8" Hole	OP-INSTL8512	\$2.64	
Padlock Hasp 1/2" Diameter	OP-INSTL8536	\$2.20	

Applications

Description	Installed by SBP Option Code	
Weld tabs to post	OP-TAB2POST	\$4.14
Weld tabs to panel	OP-TAB2PANL	\$4.14



STEEL SHEETS

Product Line: Z9999

Perforated Metal - 24 Gauge

Price Code: L11

Description	Installed by SBP	
	Option Code	Price
3/32" Diameter - "Large Hole", 36" x 84"	OP-INSTL3980	Call
3/32" Diameter - "Large Hole", 48" x 84"	OP-INSTL3981	for
3/32" Diameter - "Large Hole", 48" x 96"	OP-INSTL3982	quote.
Solid Steel Sheet, 24 Gauge, 48" x 96"	OP-INSTL3970	
Solid Steel Sheet, 24 Gauge, 36" x 24"	OP-INSTL3972	Call
Solid Steel Sheet, 24 Gauge, 48" x 24"	OP-INSTL3973	for
Solid Steel Sheet, 24 Gauge, 36" x 36"	OP-INSTL3975	quote.
Note: Cutting charge for custom sizes. Add to the next larger size:		
Cut Perf to Size	OP-CUTPERF	\$7.20

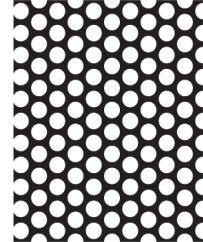

Color Options

Description	Installed by SBP	
	Option Code	Price
Perf/Mesh Color - Adobe	OP-PERF-AD	
Perf/Mesh Color - Almond	OP-PERF-AL	
Perf/Mesh Color - Black	OP-PERF-BK	Call
Perf/Mesh Color - Bronze	OP-PERF-BZ	for
Perf/Mesh Color - Weathered Brown	OP-PERF-WB	quote.
Perf/Mesh Color - White	OP-PERF-WH	
Perf/Mesh Color - Custom Color	OP-PERF-CC	

STEEL SHEETS

Product Line: Z9999

Expanded Metal

Price Code: L11

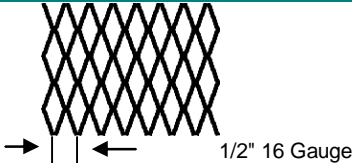
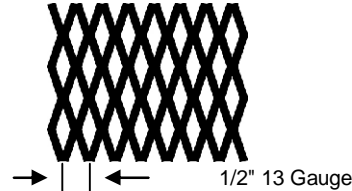
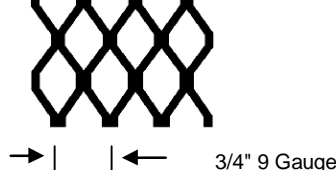
Description	Installed by SBP		
	Option Code	Price	
1/2" Expanded Metal, 16 Gauge, 48" x 96"	OP-INSTL3990	Call	
1/2" Expanded Metal, 13 Gauge, 48" x 96"	OP-INSTL3997	for	
3/4" Expanded Metal, 9 Gauge, 48" x 96"	OP-INSTL3999	quote.	
1/2" Expanded Metal, 16 Gauge, 36" x 24"	OP-INSTL3991	Call for quote.	
1/2" Expanded Metal, 16 Gauge, 48" x 24"	OP-INSTL3992		
1/2" Expanded Metal, 16 Gauge, 36" x 36"	OP-INSTL3993		
1/2" Expanded Metal, 16 Gauge, 48" x 36"	OP-INSTL3994		
Note: Cutting charge for custom sizes. Add to the next larger size: Cut Perf/Mesh to Size	OP-CUTPERF	\$7.20	

Color Options

Description	Installed by SBP		
	Option Code	Price	
Perf/Mesh Color - Adobe	OP-PERF-AD	Call for quote.	
Perf/Mesh Color - Almond	OP-PERF-AL		
Perf/Mesh Color - Black	OP-PERF-BK		
Perf/Mesh Color - Bronze	OP-PERF-BZ		
Perf/Mesh Color - Weathered Brown	OP-PERF-WB		
Perf/Mesh Color - White	OP-PERF-WH		
Perf/Mesh Color - Custom Color	OP-PERF-CC		

TERMS AND CONDITIONS

1. Prices:

Prices are those in effect on the date of shipment and are subject to change without notice. Where there is a discrepancy between the catalog and invoice, the invoice price prevails.

2. Quotes:

We will honor all written quotes for a period of 30 days. All verbal quotes not confirmed in writing will not be honored.

3. Ordering:

All orders are accepted subject to availability of merchandise. We will not be held responsible for strikes, accidents, or any other cause beyond our control. All orders are confirmed via fax or e-mail, and are the customer's responsibility to verify.

4. Terms:

- a. Net 10th, on established credit, No discounts allowed. If you wish to obtain an "open account" with SBP, please complete our credit application in full and return to us by mail, fax or e-mail. Please allow ample time for processing.
- b. C.O.D Credit Card Account, Debit Card, Visa, MasterCard or American Express. This method is preferred over C.O.D.

5. Delivery:

On your normal scheduled delivery day, we offer free delivery via our trucks to most major populated areas of Southern California on orders of **\$150.00** or more.

In major lower and upper desert areas and certain mountain areas, we offer free delivery via our trucks on orders of **\$250.00** or more.

All other areas of California outside of our normal delivery area will be delivered free via our trucks on orders of **\$2000.00** or more.

All deliveries or shipments other than stated above will be shipped via "common carrier" at customer's expense.

Certain conditions may apply per delivery area. Contact your account manager or customer service for delivery schedule.

6. Job Site or Drop Shipment Deliveries:

"Job Site" or "Drop Shipment" deliveries are available in your area on normal scheduled delivery days. A \$75.00 "Job Site" or "Drop Shipment" fee will apply. All C.O.D. job site deliveries shall be paid prior to the delivery.

7. F.O.B. Point:

All prices are quoted F.O.B. our warehouse.

8. Freight:

In all "common carrier" shipments, the transportation company is responsible for all merchandise after having accepted it for shipment in good order. All claims and correspondence for loss or damaged material must be made against the transportation company.

9. Back Orders:

SBP strives to keep adequate stock on all standard goods and will ship all back ordered items when available unless otherwise requested.

10. Claims:

Claims for damaged material, shortages or errors must be reported within five working days after receipt of shipment.

All claims reported after the five working day grace period will be subject to SBP authorization.

11. Returns:

Returns will not be accepted without SBP authorization. NON-STOCKED, CUSTOM OR SPECIAL ORDER PRODUCTS CANNOT BE RETURNED. All authorized returns may be subject to a 15% re-stocking fee. All items that arrive with damaged packaging will be subject to a \$20.00 re-packaging fee.

DAMAGED PRODUCTS ARE NOT RETURNABLE,
NO EXCEPTIONS.

12. Custom Orders:

A signed confirmation must be received by SBP before any custom orders are scheduled for production. SBP is not responsible for any errors and/or omissions in customer verified information.

C.O.D. Custom Orders:

All C.O.D. custom orders must have a 50% non-refundable deposit towards the invoice before production takes place.

13. Product Warranty:

All **non-steel** products are warranted against defects in workmanship only for a period of one full year.

Economy steel products are warranted against defects in workmanship and finish only for a period of three full months.

Domestic Steel Finish Warranty:

One Year: on Black, Bronze, Almond and Adobe.
All other colors carry a six month warranty.

Domestic steel products are warranted against defects in workmanship only for a period of one full year.

SBP is not liable for any materials that have been altered or modified in any way.

Note:

All steel products are susceptible to rust. Rust preventative maintenance is necessary to preserve the finish of these products. This warranty does not apply to installations within five miles of the ocean or around the perimeter of swimming pools where moisture, salt and chemicals can easily damage the finish.

This guarantee is void if the product has been subject to improper installation or mechanical damage indicative of obvious mistreatment or abuse.

Under no circumstances will SBP be held responsible for labor charges occurring from job site repair or replacements.